



xylem

Professional Data Loggers

FOR VALIDATION, ROUTINE CONTROL AND PROCESS MONITORING

MEDICINE

FOOD

PHARMACEUTICAL

LABORATORY

-ebro-
a xylem brand

2021

You can find more catalogues on our website:



 Professionelle Datenlogger
(Part No. 1347-0101)



 Professionelle Messtechnik
(Part No. 1347-0100)



 Professional Measurement Technology
(Part No. 1347-0099)



If you would like to receive further catalogue copies please send your request via e-mail to ebro@xylem.com







KompetenzCentrum ebro®

Theory and practice combined are the key to our successful transfer. Our instructors are all experts in their own fields. The aim is to achieve an in-depth understanding of hardware and software alike.



Seminar program 2021

- | | |
|--|--|
|  17.03. - 18.03.2021 | Validation DAC-Universal MK III and MK IV |
|  22.09. - 23.09.2021 | |
|  08.02. - 12.02.2021 | Validation training VALI B corresponding to the framework curriculum of the DGSV

Extensions/Alterations to the course modules will be taken into account at the next possible date

Seminar location: Ingolstadt, Germany |
|  03.05. - 08.05.2021 | |
|  06.12. - 11.12.2021 | |
|  30.03.2021 | Advanced course measurement technology for food control |
|  23.06. - 24.06.2021 | System validation in the hospital and in the resident field (Basic course) |
|  13.04. - 15.04.2021 | Validation Basic Training for Distributors and their costumers |

Information: Further dates on request. Requirement: 6 participants at least

-  English spoken seminar
-  German spoken seminar

You can find the current program on our homepage
www.ebro.com/en/training



Contents

New Data Logger from the EBI 12 series	3		
Data Loggers	4		
Logger systems	6		
EBI 12-T100 Temperature Data Logger	11		
EBI 12-T10X Temperature Data Logger	11		
EBI 12-T21X Temperature Data Logger	12		
EBI 12-T23X Temperature Data Logger	12		
EBI 12-T285 Temperature Data Logger	13		
EBI 12-T43X Temperature Data Logger	13		
EBI 12-T26X Bottle Logger	14		
EBI 12-T46X Bottle Logger	14		
EBI 12-T22X Temperature Data Logger	15		
EBI 12-T24X Temperature Data Logger	15		
EBI 12-T421 Temperature Data Logger	16		
EBI 12-T441 Temperature Data Logger	16		
EBI 12-T490 Temperature Data Logger	17		
EBI 12-T690 Temperature Data Logger	17		
EBI 12-T47X Temperature Data Logger	18		
EBI 12-T671 Temperature Data Logger	18		
EBI 12-TP222 Temperature / Pressure Data Logger	20		
EBI 12-TP226 Temperature / Pressure Data Logger	20		
EBI 12-TP231 Temperature / Pressure Data Logger	21		
EBI 12-TP23X Temperature / Pressure Data Logger	22		
EBI 12-TP322 Temperature / Pressure Data Logger	22		
EBI 12-TP422 Temperature / Pressure Data Logger	23		
EBI 12-TP45X Temperature / Pressure Data Logger	23		
EBI 12-TP460 Temperature / Pressure Data Logger	24		
EBI 12-TPX9X Precision Pressure Logger	24		
EBI 12-TC230 Temperature / Conductivity Data Logger	25		
EBI 12-T480 Temperature Data Logger	25		
EBI 12-TH100-EX Temperature / Humidity Data Logger	26		
EBI 16 Alternative Bowie&Dick-Test	27		
AL 285 Logger-Check	30		
EBI 11-T210 Mini Temperature Data Logger	34		
EBI 11-T230 to T233 Mini Temperature Data Logger	34		
EBI 11-T235 to T237 Mini Temperature Data Logger	35		
EBI 11-T240 Mini Temperature Data Logger	35		
EBI 11-P100 Mini Temperature / Pressure Data Logger	37		
EBI 11-P111 Mini Temperature / Pressure Data Logger	37		
EBI 11-TP110 Mini Temperature / Pressure Data Logger	38		
EBI 11-TP210 Mini-Temperature / Pressure Data Logger	38		
Data Logger Sets	42		
Data Logger Sets for process and charge control, for routine control, mapping and Acceptable Quality Limit (AQL)	44		
SL 1011 Temperature Data Logger Set	44		
SL 1111 Temperature / pressure data logger set	45		
SL 1521 EBI 16 Bowie&Dick-Test Set	46		
SL 1621 EBI 16 Bowie&Dick-Test and Process Control Set	46		
SL 400X EBI 11 Mini Data Logger Set for Pasteurization and Sterilization	47		
SL 402X EBI 12 Data Logger Set for Pasteurization and Sterilization	48		
SL 4102 EBI 11 Mini Data Logger Set for Pasteurization	48		
SL 412X EBI 12 Data Logger Set for Pasteurization	49		
SL 4211 EBI 12 Basic Temperature Monitoring Set	49		
Data Logger Sets for Operation and Process Qualification	50		
SL 2002 Complete Validation Set	50		
SL 3001 Complete Validation Set	51		
SL 3101 Complete Validation Set	51		
SL 3111 Complete Validation Set	52		
AL 3305 DAC Adapter Set	52		
SL 3302 Complete Validation Set	53		
AL 126 Test adapter for hollow bodies and hoses	55		
AL 127 Trolley „SYSTAINER“	56		
PHT 830 pH Meter	57		
CT 830 Conductivity Meter	57		
PHX 800 Basic pH Tester	59		
TDS 3 Basic Conductivity Tester	59		
Process Monitoring	60		
EBI 40 Multi-Channel Temperature Data Logger	62		
EBI 40-TC Multi-Channel Data Logger	63		
EBI 25 Wireless Data Logger System	64		
EBI 25-T Wireless Temperature Data Logger	66		
EBI 25-TE Wireless Temperature Data Logger	66		
EBI 25-TX Wireless Temperature Data Logger	67		
EBI 25-TH Wireless Temperature / Humidity Data Logger	67		
EBI 310 PDF Data Loggers	70		
EBI 310 Multi-Use PDF Data Logger	73		
EBI 310 TE Multi-Use PDF Data Logger with external precision temperature probe	74		
EBI 310 TH Multi-Use PDF Data Logger with external humidity and temperature probe	75		
EBI 310 TX Multi-Use PDF Data Logger with temperature-two-channel-adapter	75		
Software	78		
Simplification and support in qualifying the measurement system	80		
Evaluation Software for Any Applications	82		
Winlog.pro	83		
Evaluation Software for EBI 25 Data Loggers	84		
Winlog.web	85		
TÜV certified evaluation Software for Pharmaceutical and Medical Applications	86		
Winlog.med	87		
Winlog.validation	87		
Calibration	88		
Factory Calibration	88		
Calibration according to ISO 9000	89		
Calibration conditions for different calibrations	91		
Declarations	93		
Conditions of Delivery and Payment	94		
www.ebro.com	97		



FOOD

PHARMA-
CEUTICAL

MEDICAL



INDUSTRIAL

New Data Logger from the EBI 12 series



EBI 12-T222

The logger reacts very quickly on temperature changes caused by the small and fast probe. It is therefore ideally suited for temperature measurement during process validation.

Technical details on page 15



EBI 12-T237

The data logger can be used in several measurement applications in the food and pharmaceutical industries. For example in stability chambers, retort sterilization and in pasteurization tunnels.

Technical details on page 12



EBI 12-TP237

This data logger is used for simple pressure checks in pipelines as well as in the washer-disinfectors or even steam sterilizers.

Technical details on page 22



EBI 12-T26x

The new bottle loggers with a temperature probe are characterized by their robustness and easy handling. With the M10 thread, they can easily be attached to the bottle adapter and the probe can be brought into the optimal position for measurement.

Technical details on page 14

Data Loggers

ebro® offers data loggers for many different applications:



Operation and Process qualification

Description:

- Highly accurate temperature, pressure, humidity and conductivity data loggers for thermal validation processes
- Wide range of probe types and configurations
- Wireless data loggers for real time monitoring
- Data loggers for low space

Applications:

- Process validation in steam sterilizers, autoclaves, in the production of canning, a.s.o.
- Process validation in washer-disinfectors and washer-disinfectors for endoscopes
- F_0 -value and A_0 -value calculation
- Process validation in low temperature sterilizers such as EtO, LTSF and H_2O_2

Routine control / Mapping

Description:

- Highly accurate temperature, pressure, humidity and conductivity data loggers for thermal process control
- Electronic Bowie&Dick-Test according to ISO 17665 and EN 285 / EN 13060
- Data loggers for low space
- Data loggers for regular process controls

Applications:

- Routine control in steam sterilizers and autoclaves
- Routine control in washer-disinfectors and washer-disinfectors for endoscopes
- Routine control at canning
- Mapping





Room Monitoring and Process control

Description:

- Highly accurate temperature, pressure and humidity data loggers
- Standard temperature and humidity data loggers with automatic PDF report generation
- Wireless system to monitor temperature and humidity
- Multichannel Thermo Couple temperature data loggers

Applications:

- Room monitoring
- Transport and storage monitoring
- Clean room and freezer monitoring

Logger systems

and accessories for Process monitoring, Routine control and Validation



Food



Applications

- Autoclaves / Sterilizers / Pasteurization Processes
- Continuous Fryers
- Lyophilization
- Hydrostatic Retorts
- Refrigerators / Freezers / Cooling Rooms
- Smokehouse
- Cooker / Cooler (Reel and Spiral)



Medical



- Steam Sterilization
- Washer disinfectors / bedpan washers
- H₂O₂-, LTSF- and EtO- Sterilization
- Depyrogenation / heat tunnel
- Incubators
- Refrigerators / Freezers / Cooling Rooms
- Stability Chambers



Pharmaceutical



- Steam-, H₂O₂ and EtO- Sterilization
- Washer disinfectors
- Depyrogenation / heat tunnel
- Lyophilization
- Incubators
- Refrigerators / Freezers / Cooling Rooms
- Climatic Test Chambers / Stability Chambers

Products



EBI 11 Series



EBI 12 Series



EBI 310 Series



EBI 25 Series



EBI 40



EBI 11 Series



EBI 12 Series



EBI 16



EBI 310 Series



EBI 25 Series



EBI 40



EBI 11 Series



EBI 12 Series



EBI 16



EBI 310 Series



EBI 25 Series



EBI 40

Process monitoring, Routine Control and Validation easy and safe

Validation

Is a reproducible proof that a process permanently generates the required results.

Validation is a clear demonstration that processes, equipment, materials, work steps or systems actually lead to the expected results.

Routine Control

Routine control is a regular test to determine the performance of the equipment. It is the verification that the limits are in accordance to the validation.

The frequency depends on the device and the process.

Continuous Process Monitoring

The continuous process check as a validated status during the commercial manufacturing process ensures that the ongoing process remains under continuous control. The recognition of unplanned deviations from the plan is indispensable to the achievement of the set objectives and the conformity with the requirements.

EX Area

Hazardous areas (except for mining)

The categories 1 to 3 are classified according to the ATEX Directive 94/9 / EC. The letter "G" stands for gas. In the IEC 60079-0 for electrical components and devices, and thus for approvals according to the IECEx scheme, Equipment Protection Levels (EPL) are defined.

Devices according to Category 1G or EPL Ga

Devices must be designed in such a way as to ensure a very high degree of safety. Devices of this category must also ensure the required degree of safety even in the case of infrequent disturbances. Even if there are two faults on the unit, ignition must not occur. They may be used in Zone 0 (Category 1G).

Requirement for reprocessing of medical devices

Reprocessing of medical devices coming to an intended application as low-germ or sterile is to perform.

By using the manufacturer's instructions with suitable validated process and procedures, that the success of this procedure is reproducible and do not endanger the safety and health of patients, user and third parties.

Data Logger Systems

ebro® is specialist for measuring systems for flexible and reliable measurement and documentation systems for routine control and validation of various thermal processes in the medical field, the pharmaceutical and the food industry.

Our product range covers easy to use data loggers of the EBI 12 and EBI 11 series, which are placed directly in the process. An intuitive, TÜV certified software to routine testing or validation of processes assists to evaluate your process data.

In addition, we offer you the certified EBI 16 system to perform the daily Bowie&Dick-test with a clear „fail“ or „passed“ result.

TÜV certified evaluation software Winlog.med and Winlog.validation

With the Winlog.med / Winlog.validation we offer a TÜV certified, FDA 21 CFR Part 11 compliant software. The system is characterized by high data security. The automatic evaluation of the process is possible as well as the manual evaluation.

The software offers the possibility to create user defined evaluations. So it is possible to create individual process parameters and test criteria.



Conformance

Our systems are compliant with the relevant standards and guidelines.

DIN EN ISO 17665	Sterilization of health care products. - Moist heat - Requirements for the development, validation and routine control of a sterilization process for medical devices
DIN EN 285	Sterilization - Steam sterilizers - Large sterilizer
DIN EN ISO 15883	Washer disinfectors - General requirements, terms and definitions and tests
DIN EN 13060	Small steam sterilizers
DIN SPEC 58929	Operation of small steam sterilizers in health care - Guidelines for validation and routine monitoring of sterilization processes
DIN EN ISO 11135	Sterilization of health care products - Ethylene oxide - Requirements for the development, validation and routine control of a sterilization process for medical devices.
DIN EN ISO 25424	Sterilization of medical devices - Low temperature steam and formaldehyde - Requirements for development, validation and routine control of a sterilization process for medical devices.
DIN EN ISO 11140-4	Sterilization of health care products - Chemical indicators - Class 2 indicators as an alternative to the Bowie&Dick-type test for detection of steam penetration.
DIN EN ISO 9241	Ergonomics of human-system interaction: Dialogue principles
DIN 12880	Electrical laboratory equipment - heaters and incubators
DIN EN ISO 13408-3	Aseptic processing of healthcare products -- Part 3: Lyophilization
DIN EN ISO 14937	Sterilization of healthcare products -- General requirements for characterization of a sterilizing agent and the development, validation and routine control of a sterilization process for medical devices.
ISO/IEC 25051	Software engineering -- Systems and software Quality Requirements and Evaluation (SQuaRE) -- Requirements for quality of Ready to Use Software Product (RUSP) and instructions for testing
FDA 21 CFR Part 11	Is the part of the FDA regulations about electronic records and electronic signatures, specifies the criteria under which electronic records and electronic signatures can be considered trustworthy and reliable as a paper document
FDA 21 CFR Part 210-211	Defines minimum requirements for the methods to be dispatched in the manufacture, processing, packaging and warehousing of drugs and vaccine and distribution and controls to be used.
Guidelines	Guidelines from DGKH, DGSV and AKI for the validation and routine monitoring of machine cleaning and thermal disinfection processes for medical devices
Recommendations	DGKH recommendations for validation and routine monitoring of sterilization processes with moist heat for medical devices

Temperature data loggers of EBI 12 series

General technical specifications for EBI 12 T series

Operating temperature: logger	-90 °C ... +150 °C (-130 °F ... +302 °F)*
Operating temperature: radio operation	-30 °C ... +150 °C (-22 °F ... +302 °F)
Temperature accuracy	±1.5 °C (-200 °C ... -90 °C)* ±0.5 °C (-90 °C ... -40 °C)* ±0.2 °C (-40 °C ... 0 °C)* ±0.1 °C (0 °C ... +120 °C)* ±0.05 °C (+120 °C ... +140 °C)* ± 0.1 °C (+140 °C ... +150 °C)* ± 0.5 °C (+150 °C ... +250 °C)* ± 0.8 °C (+250 °C ... +400 °C)*
Time accuracy	< 5 sec (24 h)
Temperature resolution	0.01 °C
Sensor	Pt 1000, Class A
Interval	250 ms ... 24 hours.*
Measurement mode	<ul style="list-style-type: none"> • Endless measurement • Start / stop measurement • Measure upon start temperature • Start immediately until end of memory
Storage temperature	-20 °C ... +70 °C (-4 °F ... +158 °F)
Maximum operating pressure	Temperature logger 10 bar (abs), 4 bar (abs) with flexible cable probes
Minimum operating pressure	Logger with flexible cable probe 20 mbar (abs)
Battery	Lithium cell, 3.6 V, user replaceable
Dimensions (Ø x H)	48 mm x 24 mm**
Weight	Approximately 110 g **
Housing material	316 L Stainless steel / PEEK
Protection class	IP68
Certificate	Factory calibration certificate

* Deviating specifications can be found in the product descriptions.

** Dimensions and weight may be different depending on the type.

Product lines



Data loggers with this symbol have flexible or bendable temperature sensors or, in addition to temperature, can also log other measurands such as pressure, humidity, conductivity. The measured values can be transmitted via radio mode. Field of applications for the data logger of the EBI 12 series are: medicine, pharmaceuticals, food & beverages, as well as industry.

Temperature data loggers with this symbol have usually rigid temperature probes. They are characterized by their easy handling and robustness. Data loggers in this line of products have good accuracy and data memory. Most data loggers have a mounting thread for easy fixation.

The data logger can be used in several measurement applications in the food and pharmaceutical industries. For example in stability chambers, retort sterilization and in paste station tunnels.

EBI 12-T100 Temperature Data Logger with internal temperature sensor



II1G Ex ia IIC T4 Ga



Application samples

- For process monitoring during convenience food production
- For routine control in bedpan washers
- For temperature mappings
- To measure in raw material storage

Technical Data

Measurement range	EBI 12-T100: -90 °C ... +150 °C (-130 °F ... +302 °F) EBI 12-T100-EX: -40 °C ... +85 °C (-40 °F ... +185 °F)
Data memory	100,320 measurement values
Factory calibration certificate	-20 °C, 0 °C, +60 °C and +134 °C
Radio mode	EBI 12-T100: Not possible EBI 12-T100-EX: Selectable

EBI 12-T100-EYELET expected to be available from Q2 2021.

- 1 internal temperature sensor
- Particularly robust

Type	Description	Part No.
EBI 12-T100	Internal temperature sensor	1340-6600
EBI 12-T100-EYELET	Internal temperature sensor and eyelet ring	1340-6600-0100
EBI 12-T100-EX	Internal temperature sensor	1340-6600-EX

EBI 12-T10X Temperature Data Logger with internal temperature sensor



Application samples

- For use in dry ice and in cryogenic
- In bedpan washers and washing machines

Technical Data

Measurement range	EBI 12-T101: -90 °C ... +105 °C (-130 °F ... +221 °F) EBI 12-T102: -90 °C ... +60 °C (-130 °F ... +140 °F)
Accuracy	± 0.5 °C (-90 °C ... -40 °C) ± 0.3 °C (-40 °C ... +105 °C)
Sampling rate	1 s ... 24 h
Data memory	27,840 measurement values
Factory calibration certificate	EBI 12-T101: -20 °C, 0 °C and +60 °C EBI 12-T102: -80 °C, 0 °C and +60 °C

EBI 12-T101-EYELET and EBI 12-T102 expected to be available from Q2 2021.

- 1 internal temperature sensor
- Particularly robust

Type	Description	Part No.
EBI 12-T101	Internal temperature sensor	1340-6601
EBI 12-T101-EYELET	Internal temperature sensor and eyelet ring	1340-6601-0100
EBI 12-T102	Internal temperature sensor for Dry Ice	1340-6636

EBI 12-T21X Temperature Data Logger

rigid metal probe



Application sample

- For process monitoring during convenience food production

Technical Data

Measurement range	-55 °C ... +150 °C (-67 °F ... +302 °F)
Accuracy	± 0.5 °C (-55 °C ... -40 °C) ± 0.2 °C (-40 °C ... 0 °C) ± 0.1 °C (0 °C ... +150 °C)
Sampling rate	1 s ... 24 h
Data memory	27,840 measurement values
Factory calibration certificate	-20 °C, 0 °C, +60 °C and +134 °C



- 1 external temperature probe, Ø 3 mm
- Radial pointed

Type	Description	Part No.
EBI 12-T210	Needle length = 50 mm	1340-6602
EBI 12-T211	Needle length = 75 mm	1340-6603

EBI 12-T23X Temperature Data Logger

rigid metal probe



Application sample

- Ideal for use in canning for pasteurization control

Technical Data

Measurement range	-55 °C ... +150 °C (-67 °F ... +302 °F)
EBI 12-T230 - EBI 12-T233	-40 °C ... +140 °C (-40 °F ... +284 °F)
Accuracy	± 0.5 °C (-55 °C ... -40 °C) ± 0.2 °C (-40 °C ... 0 °C) ± 0.1 °C (0 °C ... +150 °C)
Sampling rate	1 s ... 24 h
Data memory	27,840 measurement values
Factory calibration certificate	-20 °C, 0 °C, +60 °C and +134 °C

- Axial pointed, M5 Thread
- 1 external temperature probe, Ø 3 mm
- Various needle lengths available

Type	Description	Part No.
EBI 12-T230	Needle length = 50 mm	1340-6606
EBI 12-T231	Needle length = 75 mm	1340-6607
EBI 12-T232	Needle length = 100 mm	1340-6608
EBI 12-T233	Needle length = 150 mm	1340-6609
EBI 12-T237	Needle length = 100 mm	1340-6637

EBI 12-T285 Temperature Data Logger *bendable, blunt metal probe*



Application sample

- For retort maintenance and process monitoring

Technical Data

Measurement range	-40 °C ... +200 °C (-40 °F ... +392 °F)
Accuracy	± 0.2 °C (0 °C ... +150 °C) ± 0.3 °C (-40 °C... 0 °C) ± 0.5 °C > 150 °C
Sampling rate	1 s ... 24 h
Data memory	100,320 measurement values
Factory calibration certificate	-20 °C, 0 °C, +60 °C and +134 °C

- 1 external temperature probe, Ø 3 mm
- Axial, blunt

Type	Description	Part No.
EBI 12-T285	Needle length = 2,000 mm	1340-6685

EBI 12-T43X Temperature Data Logger *rigid metal probes*



Application sample

- Ideal for use in canning for pasteurization control

Technical Data

Measurement range	-55 °C ... +150 °C (-67 °F ... +302 °F)
Accuracy	± 0.5 °C (-55 °C ... -40 °C) ± 0.2 °C (-40 °C... 0 °C) ± 0.1 °C (0 °C ... +150 °C)
Sampling rate	1 s ... 24 h
Data memory	2 x 13,920 measurement values
Factory calibration certificate	-20 °C, 0 °C, +60 °C and +134 °C

- Axial pointed, M5 Thread
- 2 external temperature probes, Ø 3 mm
- Various needle lengths available

Type	Description	Part No.
EBI 12-T430	Needle length = 50 mm	1340-6614
EBI 12-T431	Needle length = 75 mm	1340-6615
EBI 12-T432	Needle length = 100 mm	1340-6616
EBI 12-T433	Needle length = 150 mm	1340-6617

EBI 12-T26X Bottle Logger rigid metal probe



NEW

EBI 12



Application sample

- Temperature measurement in bottles during pasteurization

Technical Data

Measurement range	-55 °C ... +140 °C (-67 °F ... 284 °F)
Accuracy	± 0.8 °C (-55 °C ... -40 °C) ± 0.3 °C (-40 °C ... +140 °C)
Sampling rate	1 s ... 24 h
Data memory	27.840 measurement values
Factory calibration certificate	-20 °C, 0 °C, +60 °C and +121 °C

Expected to be available from Q2 2021.

- Axial, blunt, M10 thread
- 1 external temperature probe, Ø 6 mm
- Various needle lengths available

Type	Description	Part No.
EBI 12-T261	Needle length = 135 mm	1340-6618
EBI 12-T262	Needle length = 190 mm	1340-6619
EBI 12-T263	Needle length = 245 mm	1340-6620
EBI 12-T264	Needle length = 270 mm	1340-6621
EBI 12-T265	Needle length = 300 mm	1340-6622

EBI 12-T46X Bottle Logger rigid metal probe



EBI 12



Application sample

- Ideal for use in bottles

Technical Data

Measurement range	-55 °C ... +150 °C (-67 °F ... +302 °F)
Accuracy	± 0.5 °C (-55 °C ... -40 °C) ± 0.2 °C (-40 °C ... 0 °C) ± 0.1 °C (0 °C ... +150 °C)
Sampling rate	1 s ... 24 h
Data memory	2 x 13,920 measurement values
Factory calibration certificate	-20 °C, 0 °C, +60 °C and +121 °C

- Axial, blunt, M10 thread
- 1 external temperature probe, Ø 6 mm
- 1 external temperature probe, Ø 3 mm
- Various needle lengths available

Type	Description	Part No.
EBI 12-T461	Needle length = 135 mm	1340-6623
EBI 12-T462	Needle length = 190 mm	1340-6624
EBI 12-T463	Needle length = 245 mm	1340-6625
EBI 12-T464	Needle length = 270 mm	1340-6626
EBI 12-T465	Needle length = 300 mm	1340-6627

EBI 12-T22X Temperature Data Logger bendable metal probe



II1G Ex ia IIC T4 Ga

Application samples

- Measurement in drain of sterilizers
- In oven (protected by Thermal-Isolation-Box)
- EtO sterilization (ATEX type)



Technical Data

Measurement range (Use in EX Area)	EBI 12-T220: -200 °C ... +200 °C (-328 °F ... +392 °F) EBI 12-T220-EX: -40 °C ... +85 °C (-40 °F ... +185 °F) EBI 12-T221: -200 °C ... +400 °C (-328 °F ... +752 °F) EBI 12-T222: -55 °C ... +140 °C (-67 °F ... +284 °F)
Data memory: EBI 12-T220 - EBI 12-T221: EBI 12-T222	100,320 measurement values 27,840 measurement values
Factory calibration certificate	-20 °C, 0 °C, +60 °C, +134 °C and +250 °C if the probe length is 500 mm

EBI 12-T222 expected to be available from Q3 2021.

- 1 external temperature probe, Ø 1.5 mm
- Radial arranged

Type	Description	Part No.
EBI 12-T220	Needle length = 250 mm	1340-6604
EBI 12-T220-EX	Needle Length = 250 mm	1340-6604-EX
EBI 12-T221	Needle length = 500 mm	1340-6605
EBI 12-T222	Needle length = 40 mm, rigid, M5 thread	1340-6610

EBI 12-T24X Temperature Data Logger bendable metal probe



Application samples

- In washer disinfectors
- H₂O₂ sterilization

Technical Data

Measurement range	-200 °C ... +200 °C (-328 °F ... +392 °F)
Data memory	100,320 measurement values
Factory calibration certificate	-20 °C, 0 °C, +60 °C and +134 °C

- 1 external temperature probe, Ø 1,5 mm
- Axial arranged

Type	Description	Part No.
EBI 12-T240	Needle Length = 250 mm	1340-6611
EBI 12-T241	Needle Length = 500 mm	1340-6612

EBI 12-T421 Temperature Data Logger

bendable metal probes



Application samples

- In oven (protected by Thermal-Isolation-Box)
- In washer disinfectors

Technical Data

Measurement range	-200 °C ... +400 °C (-328 °F ... +752 °F)
Data memory	2 x 50,160 measurement values
Factory calibration certificate	-20 °C, 0 °C, +60 °C, +134 °C and +250 °C

- 2 external temperature probes, Ø 1.5 mm
- Radial arranged

Type	Description	Part No.
EBI 12-T421	Needle Length = 500 mm	1340-6630

EBI 12-T441 Temperature Data Logger

bendable metal probes



II1G Ex ia IIC T4 Ga



Application samples

- In washer disinfectors
- H₂O₂ sterilization
- EtO sterilization (ATEX type)

Technical Data

Measurement range	EBI 12-T441: -200 °C ... +200 °C (-328 °F ... +392 °F)
(Use in EX Area)	EBI 12-T441-EX: -40 °C ... +85 °C (-40 °F ... +185 °F)
Data memory	2 x 50,160 measurement values
Factory calibration certificate	-20 °C, 0 °C, +60 °C and +134 °C

- 2 external temperature probes, Ø 1.5 mm
- Axial arranged

Type	Description	Part No.
EBI 12-T441	Needle Length = 500 mm	1340-6629
EBI 12-T441-EX	Needle Length = 500 mm	1340-6629-EX

EBI 12-T490 Temperature Data Logger flexible cable probes



Application sample

- Steam sterilizer



Technical Data

Measurement range	-20 °C ... +150 °C (-4 °F ... +302 °F)
Data memory	2 x 50,160 measurement values
Factory calibration certificate	0 °C, +60 °C and +134 °C

- 2 external temperature probes, Ø 1.2 mm
- Radial arranged

Type	Description	Part No.
EBI 12-T490	Cable Length = 600 mm	1340-6634

EBI 12-T690 Temperature Data Logger flexible cable probes



Application sample

- Steam sterilizer



Technical Data

Measurement range	-20 °C ... +150 °C (-4 °F ... +302 °F)
Data memory	4 x 25,080 measurement values
Factory calibration certificate	0 °C, +60 °C and +134 °C

- 4 external temperature probes, Ø 1.2 mm
- Radial arranged

Type	Description	Part No.
EBI 12-T690	Cable Length = 600 mm	1340-6635

EBI 12-T47X Temperature Data Logger flexible cable probes



Application sample

- Steam sterilizer



Technical Data

Measurement range	-20 °C ... +150 °C (-4 °F ... +302 °F)
Data memory	2 x 50,160 measurement values
Factory calibration certificate	0 °C, +60 °C and +134 °C

- 2 external temperature probes, Ø 1.2 mm
- Axial arranged

Type	Description	Part No.
EBI 12-T470	Cable Length = 600 mm	1340-6640
EBI 12-T471	Cable Length = 1,200 mm	1340-6644

EBI 12-T671 Temperature Data Logger flexible cable probes



Application sample

- Steam sterilizer



Technical Data

Measurement range	-20 °C ... +150 °C (-4 °F ... +302 °F)
Data memory	4 x 25,080 measurement values
Factory calibration certificate	0 °C, +60 °C and +134 °C

- 4 external temperature probes, Ø 1.2 mm
- Axial arranged

Type	Description	Part No.
EBI 12-T671	Cable Length = 1,200 mm	1340-6645

Temperature / Pressure Data Loggers EBI 12 series

General technical specifications: valid for all EBI 12-TP data loggers

Operating temperature: pressure logger	0 °C ... +150 °C (+32 °F ... +302 °F)
Accuracy: temperature	±0.1 °C (0 °C ... +120 °C) ±0.05 °C (+120 °C ... +140 °C) ±0.1 °C (+140 °C ... +150 °C)
Accuracy: pressure	±15 mbar (1 mbar ... 50 mbar) ±10 mbar (50 mbar ... 150 mbar) ±10 mbar (2,050 mbar ... 2,250 mbar) ±10 mbar (3,000 mbar ... 3,250 mbar) ±15 mbar (3,250 mbar ... 3,500 mbar) ± 0.5 % FS (3,500 mbar ... 4,000 mbar)
Resolution: temperature	0.01 °C
Resolution: pressure	1 mbar
Data memory	Max. 100,320 total measurement values
Sensor: temperature	Pt 1000, Class A
Sensor: pressure	Piezoresistive pressure sensor (temperature compensated)
Sampling rate	250 ms ... 24 h
Measurement mode	<ul style="list-style-type: none"> • Endless measurement • Measure upon start time • Start immediately until end of memory • Start / Stop measurement
Storage temperature	-20 °C ... +70 °C (-4 °F ... +158 °F)
Maximum operating pressure	Pressure logger: 7 bar (abs), 4 bar (abs) with flexible cable probes
Minimum operating pressure	Logger with flexible cable probe: 20 mbar (abs)
Time accuracy (24h)	< 5 sec
Battery	Lithium cell, 3.6 V, user replaceable
Dimensions (Ø x H)	48 mm x 32 mm*
Weight	Approximately 120 g *
Housing material	316 L Stainless steel / PEEK
Protection class	IP68
Certificate	Factory calibration certificate

* Dimensions and weight may be different depending on the type.

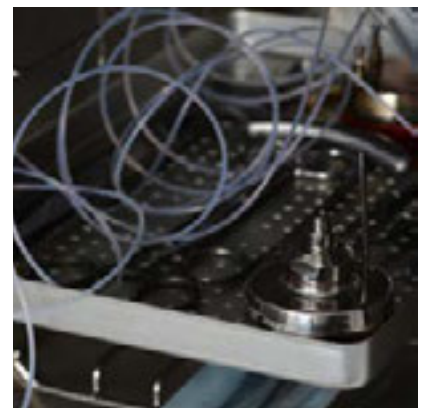

EBI 12-TP222 Temperature / Pressure Data Logger bendable metal probe and Luer-Lock-Connection



Application samples

- Washer disinfectors
- Sterilizer

Technical Data

Measurement range: temperature	0 °C ... +150 °C (+32 °F ... +302 °F)
Measurement range: pressure	1 ... 4,000 mbar
Data memory	2 x 33,440 measurement values
Factory calibration certificate	0 °C, +60 °C and +134 °C 100 mbar and 3100 mbar at +25 °C and 3100 mbar at +134 °C

- 1 external temperature probe, axial, bendable, Ø 1.5 mm
- 1 internal pressure sensor with Luer-Lock-Connection

Type	Description	Part No.
EBI 12-TP222	Needle Length = 500 mm, Luer-Lock-Connection	1340-6653

EBI 12-TP226 Temperature / Pressure Data Logger bendable metal probe



Application samples

- Washer disinfectors
- Sterilizer

Technical Data

Measurement range: temperature	0 °C ... +150 °C (+32 °F ... +302 °F)
Measurement range: pressure	1 ... 4,000 mbar
Data memory	2 x 33,440 measurement values
Factory calibration certificate	0 °C, +60 °C and +134 °C 100 mbar and 3100 mbar at +25 °C and 3100 mbar at +134 °C

- 1 external temperature probe, axial, bendable, Ø 1.5 mm
- 1 internal pressure sensor
- Small size

Type	Description	Part No.
EBI 12-TP226	Needle Length = 250 mm	1340-6657

EBI 12-TP231 Temperature / Pressure Data Logger rigid metal probe and Luer-Lock-Connection



II1G Ex ia IIC T4 Ga



Application samples

- Washer disinfectors
- Sterilizer
- EtO sterilizer (ATEX type)

Technical Data

Measurement range: temperature (Use in EX Area)	EBI 12-TP231: 0 °C ... +150 °C (+32 °F ... +302 °F) EBI 12-TP231-EX: 0 °C ... +85 °C (+32 °F ... +185 °F)
Measurement range: pressure	1 ... 4,000 mbar
Data memory	2 x 33,440 measurement values
Factory calibration certificate	0 °C, +60 °C and +134 °C 100 mbar and 3100 mbar at +25 °C and 3100 mbar at +134 °C

- 1 external temperature probe, axial, Ø 1.95 mm
- 1 internal pressure sensor with Luer-Lock-Connection

Type	Description	Part No.
EBI 12-TP231	Needle Length = 40 mm	1340-6655
EBI 12-TP231-EX	Needle Length = 40 mm	1340-6655-EX



EBI 12-TP23X Temperature / Pressure Data Logger tube connection and M 10x1 internal thread



EBI 12-TP234

Application sample

- Drainages

Technical Data

Measurement range: temperature	
EBI 12-TP237	0 °C ... +140 °C (+32 °F ... +284 °F)
EBI 12-TP234	0 °C ... +150 °C (+32 °F ... +302 °F)
Measurement range: pressure	1 ... 4,000 mbar
Data memory	2 x 33,440 measurement values
Accuracy: pressure	EBI 12-TP237 ±20 mbar
	EBI 12-TP234 ±15 mbar (1 mbar ... 50 mbar)
	±10 mbar (50 mbar ... 150 mbar)
	±10 mbar (2,050 mbar ... 2,250 mbar)
	±10 mbar (3,000 mbar ... 3,250 mbar)
	±15 mbar (3,250 mbar ... 3,500 mbar)
	± 0.5 % FS (3,500 mbar ... 4,000 mbar)
Factory calibration certificate	0 °C, +60 °C and +134 °C 100 mbar and 3100 mbar at +25 °C and 3100 mbar at +134 °C

- 1 external temperature probe, axial, Ø 1.95 mm
- 1 internal pressure sensor with tube connection

EBI 12-TP-237 expected to be available from Q2 2021.

Type	Description	Part No.
EBI 12-TP237	Needle Length = 20 mm, Tube connector	1340-6658
EBI 12-TP234	Needle Length = 40 mm, Tube connector	1340-6652

EBI 12-TP322 Temperature / Pressure Data Logger bendable metal probes with Luer-Lock-Connection



Application samples

- Washer disinfectors
- Sterilizer

Technical Data

Measurement range: temperature	0 °C ... +150 °C (+32 °F ... +302 °F)
Measurement range: pressure	1 ... 4,000 mbar
Data memory	3 x 25,080 measurement values
Factory calibration certificate	0 °C, +60 °C and +134 °C 100 mbar and 3100 mbar at +25 °C and 3100 mbar at +134 °C

- 2 external temperature probes, axial, bendable, Ø 1.5 mm
- 1 internal pressure sensor with Luer-Lock-Connection

Type	Description	Part No.
EBI 12-TP322	Luer-Lock-Connection	1340-6664

EBI 12-TP422 Temperature / Pressure Data Logger *bendable metal probes with Luer-Lock-Connection*



Application samples

- Washer disinfectors
- Sterilizer

Technical Data

Measurement range: temperature	0 °C ... +150 °C (+32 °F ... +302 °F)
Measurement range: pressure	1 ... 4,000 mbar
Data memory	4 x 20,064 measurement values
Factory calibration certificate	0 °C, +60 °C and +134 °C 100 mbar and 3100 mbar at +25 °C and 3100 mbar at +134 °C

- 3 external temperature probes, axial, bendable, Ø 1.5 mm
- 1 internal pressure sensor with Luer-Lock-Connection

Type	Description	Part No.
EBI 12-TP422	Needle Length = 500 mm, Luer-Lock-Connection	1340-6662

EBI 12-TP45X Temperature / Pressure Data Logger *flexible cable probes with Luer-Lock-Connection*



Application sample

- Sterilization

Technical Data

Measurement range: temperature	0 °C ... +150 °C (+32 °F ... +302 °F)
Measurement range: pressure	1 ... 4,000 mbar
Data memory	4 x 20,064 measurement values
Factory calibration certificate	0 °C, +60 °C and +134 °C 100 mbar and 3100 mbar at +25 °C and 3100 mbar at +134 °C

- 3 external temperature probes, axial, flexible, Ø 1.2 mm
- 1 internal pressure sensor with Luer-Lock-Connection

Type	Description	Part No.
EBI 12-TP451	Cable Length = 600 mm, Luer-Lock-Connection	1340-6643
EBI 12-TP453	Cable Length = 1,200 mm, Luer-Lock-Connection	1340-6647

EBI 12-TP460 Temperature / Pressure Data Logger flexible cable probes



Application sample

- In limited spaces e.g. in containers

Technical Data

Measurement range: temperature	0 °C ... +150 °C (+32 °F ... +302 °F)
Measurement range: pressure	1 ... 4,000 mbar
Data memory	4 x 20,064 measurement values
Factory calibration certificate	0 °C, +60 °C and +134 °C 100 mbar and 3100 mbar at +25 °C and 3100 mbar at +134 °C

- 3 external temperature probes, radial, Ø 1.2 mm
- 1 internal pressure sensor

Type	Description	Part No.
EBI 12-TP460	Cable Length = 600 mm	1340-6648

EBI 12-TPX9X Precision Pressure Logger high precision pressure measurement down to 0.1 mbar



A very precise pressure measurement is required in the process of the H₂O₂ sterilizer. The data logger measures from an absolute pressure of 0.1 mbar. Due to the very low working pressure, close to the vacuum, is a special measuring system required.



Not for use in steam sterilizer



Technical Data

Measurement range: temperature	0 °C ... +85 °C (+32 °F ... +185 °F)
Measurement range: pressure	0.1 ... 1,050 mbar (0.1 ... 788 Torr)
Accuracy: temperature	±0.1 °C
Accuracy: pressure	± 0.25 mbar (0.1 mbar ... 50 mbar) ± 5 % of measured value (50 mbar ... 100 mbar) ± 1 % FS (100 mbar ... 1,050 mbar)
Resolution: temperature	0.01 °C
Resolution: pressure	0.1 mbar
Data memory	TP190: 50,160 measurement values TP290: 33,440 measurement values
Sensor: temperature	Pt 1000
Sensor: pressure	Piezoresistive pressure sensor
Measurement cycle	250 ms ... 24 hours
Measurement mode	<ul style="list-style-type: none"> • Endless measurement immediately • Start / Stop measurement • Measure immediately until end of memory
Operating temperature	0 °C ... +85 °C
Max. operating pressure	2,000 mbar (abs.)
Battery	Lithium cell, 3.6 V, user replaceable
Dimensions (D x H)	48 mm x 35 mm
Housing material	316 L Stainless steel / PEEK
Protection class	IP68
Factory calibration certificate	0 °C and +60 °C ≤0.5 mbar, 50 mbar at +25 °C and ≤0.5 mbar, 10 mbar, 50 mbar at +60 °C

- 1 internal or 1 external temperature sensor, Ø 1.95 mm
- 1 internal pressure sensor

Type	Description	Part No.
EBI 12-TP190	Internal temp. sensor	1340-6665
EBI 12-TP290	Needle Length = 40 mm	1340-6666

EBI 12-TC230 Temperature / Conductivity Data Logger Conductivity measurement



In processes like e.g. washer disinfectors, the measurement of conductivity in the last dishwater is required. This is reasonably done in the running process without any interruption.



- 1 external temperature probe
- 1 external conductivity probe

Technical Data

Measurement range: temperature	0 °C ... +125 °C (+32 °F ... +257 °F)
Measurement range: conductivity	1 µS/cm ... 2,000 µS/cm
Accuracy: temperature	± 0.2 °C
Accuracy: conductivity	± 0.5 µS (1 µS/cm .. 20 µS/cm) ± 1.0 µS (20.1 µS/cm .. 100 µS/cm) ± 3.0 % of measured value (100.1µS/cm... 1500µS/cm) ± 5 % from the measurement range (remaining range)
Resolution: temperature	0.01 °C
Resolution: conductivity	0.1 µS/cm
Data memory	2 x 50,160 measurement values
Sensor: temperature	Pt 1000
Sensor: conductivity	Conductivity electrode
Measurement mode	<ul style="list-style-type: none"> • Endless measurement immediately • Start / Stop measurement • Measure immediately until end of memory
Measuring interval	<ul style="list-style-type: none"> • 1s ... 24h
Storage temperature	0 °C ... +125 °C (+32 °F ... +257 °F)
Max. operating pressure (burst pressure)	2.5 bar (abs.)
Battery	Lithium cell, user replaceable
Dimensions (D x H)	48 mm x 130 mm
Housing material	316 L Stainless steel / PEEK
Protection class	IP68
Factory calibration certificate	0 °C, +60 °C and +121 °C 5 µS/cm, 100 µS/cm, 1413 µS/cm at +25 °C
Radio mode	Not possible

Type	Description	Part No.
EBI 12-TC230	Temperature/Conductivity	1340-6667

EBI 12-T480 Temperature Data Logger with strip to connect external probes

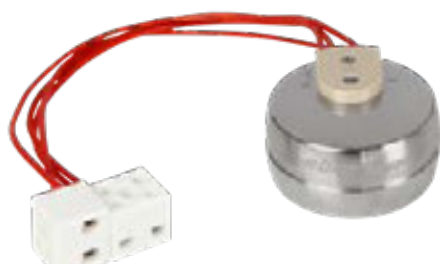

- Strip for 2 external Pt 1000 probes

Sometimes it is necessary to record data with independent probes.

Technical Data

Measurement range	-200 °C ... +400 °C (-328 °F ... +732 °F)
Data memory	2 x 50,160 measurement values
Measurement mode	<ul style="list-style-type: none"> • Endless measurement immediately • Start / Stop measurement • Measure immediately until end of memory
Operating temperature	-90 °C ... +150 °C (-130 °F ... +302 °F)
Battery	Lithium cell, 3.6 V, user replaceable
Dimensions (D x H)	46 mm x 35 mm
Housing material	316 L Stainless steel / PEEK
Protection class	IP52
Factory calibration certificate	-200 °C, -50 °C, 0 °C, +60 °C, +134 °C, +250 °C and +400 °C

Type	Description	Part No.
EBI 12-T480	Temperature Data Logger with terminal strip	1340-6633
PT 1000 Probe	10 cm long wires	1341-1810

EBI 12-TH100-EX Temperature / Humidity Data Logger usable with EtO



II1G Ex ia IIC T4 Ga



Application samples

- EtO Sterilization

Technical Data

Measurement range: Temperature (Use in EX area)	-20 °C ... +85 °C (-4 °F ... +185 °F)
Measurement range: Humidity	0 % rH ... 100 % rH
Accuracy: temperature	± 0.1 °C
Accuracy: humidity	± 2 % rH, non-condensing at +25 °C
Resolution: temperature	0.01 °C
Resolution: humidity	0.1 % rH
Data memory	2 x 50,160 measurement values
Measurement channels: temperature	external (Pt 1000)
Measurement channels: humidity	(capacitive); combined sensor replaceable
Measurement mode	<ul style="list-style-type: none"> • Endless measurement immediately • Start / Stop measurement • Measure immediately until end of memory
Measuring interval	1s ... 24h
Storage temperature	-20 °C ... +70 °C
Max. operating pressure	2 bar (abs.)
Battery	Lithium cell, 3.6 V, user replaceable
Dimensions (D x H)	48 mm x 70 mm
Housing material	316 L Stainless steel / PEEK
Protection class	IP52
Factory calibration certificate	0 °C and +60 °C 32.8 % rH, 52.9 % rH and 75.4 % rH at +25 °C

- 1 external temperature sensor (Pt 1000)
- 1 external humidity sensor (capacitive)
- Combined sensor replaceable

Type	Description	Part No.
EBI 12-TH100-EX	Temperature/Humidity	1340-6671-EX
AL 175 TH probe	Replacement probe for EBI12-TH100-EX	1341-6145



Electronic Bowie&Dick-Test for measuring steam penetration in the steam sterilizer

EBI 16 **Alternative Bowie&Dick-Test**
accordance to DIN EN 285 / ISO 17665 / ISO 11140-4



The EBI 16 forms together with the evaluation software Winlog.med an easy to use and reliable electronic measurement system.



This allows implementing a comprehensive routine control of steam sterilizers by means of the alternative Bowie&Dick-Test according to EN 285 / DIN EN ISO 17665. In addition to checking the penetration of steam, the relevant sterilization parameters are also checked.

A vacuum test can also be carried out with this device.

The EBI 16 is designed to ensure the use of 1,000 cycles or 3 years without calibration or service.

Technical Data

Measurement range temperature	0 °C ... +150 °C (+32 °F ... +302 °F)
pressure	1 mbar ... 4,000 mbar
Accuracy temperature	± 0.1 °C
pressure	± 15 mbar
Resolution temperature	0.01 °C
pressure	1 mbar
Data memory	6,960 measurement values
Sampling rate	1 sec
Measurement mode	Start / Stop measurement
Sensor: temperature	Pt 1000
Sensor: pressure	Piezoresistive pressure sensor
Operating temperature	0 °C ... +150 °C (+32 °F ... +302 °F)
Storage temperature	-20 °C ... +70 °C (-4 °F ... +158 °F)
Start temperature	+15 °C ... +35 °C (+59 °F ... +95 °F)
Max. operating pressure	7 bar (abs.)
Protection class	IP68
Battery	Lithium cell (3,6 V), replaceable
Battery lifetime	Up to 2 Years
Dimension (D x H)	90 mm x 150 mm
Housing material	316 L Stainless steel / PEEK
Weight	Approx. 500 g (incl. battery)
Calibration	Factory calibration certificate

Accordance to EN ISO 11140-4 certified by an independent laboratory

- **Reliable:** clear, reproducible measurement results
- **Accurate:** high-resolution graphical cycle display
- **Secure:** digital data recording and storage
- **Easy:** to use and evaluate

Type	Description	Part No.
EBI 16	Alternative Bowie&Dick-Test	1340-6697

Accessories and Interface-Sets



Battery replacement set AL 120
for EBI 12

Consisting of 3 batteries, 6 O-rings with grease and opening tool EBI 12

Battery set AL 104

for EBI 12

Consisting of 3 batteries, 6 O-rings with grease



AL 121 opening tool EBI 12

To open the data loggers e.g. for battery change. The set consists of 2 parts.



AL 122 eyelet ring EBI 12

Eyelet ring incl. sealing rings for EBI 12 to mount the data logger

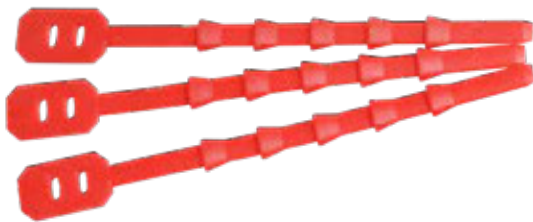

AL 190 Silicone cable strap

To hold the flexible cable probes of the EBI 12 data loggers



AL 132 Flow adapter

For a stabilized conductivity measurement in WD with EBI 12-T230



Silicone protection box

- Protects EBI 12 Data Loggers against heat peaks
- Protects EBI 12 Data Loggers against mechanical damage
- Extends the life of EBI 12 Data Loggers



Silicone protection box AL 101
for e.g.
EBI 12-TP222,
EBI 12-TP322,
EBI 12-TP422 and
EBI 12-TP45x

Silicone protection box AL 102
for e.g.
EBI 12-T24x,
EBI 12-T441 and
EBI 12-T421

Ø 78 mm,
Height: 50 mm

Ø 78 mm,
Height: 44 mm

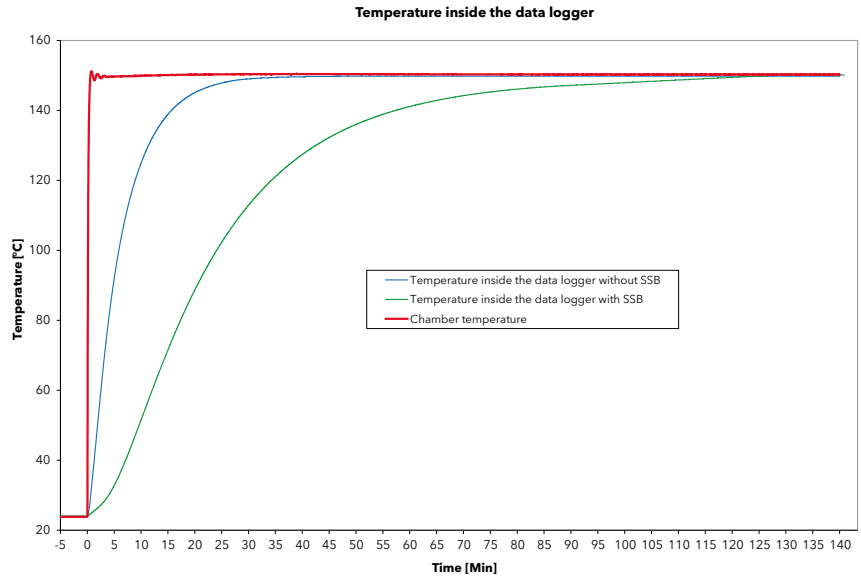

Thermal Insulation Boxes

- Usable from +150 °C ... +400 °C
- Thermal protection of data loggers
- Stainless steel



Thermal insulation box EBI TIB 2
for EBI 12-T221 and EBI 12-T421

- EBI TIB 2: 160 mm x 160 mm x 60 mm

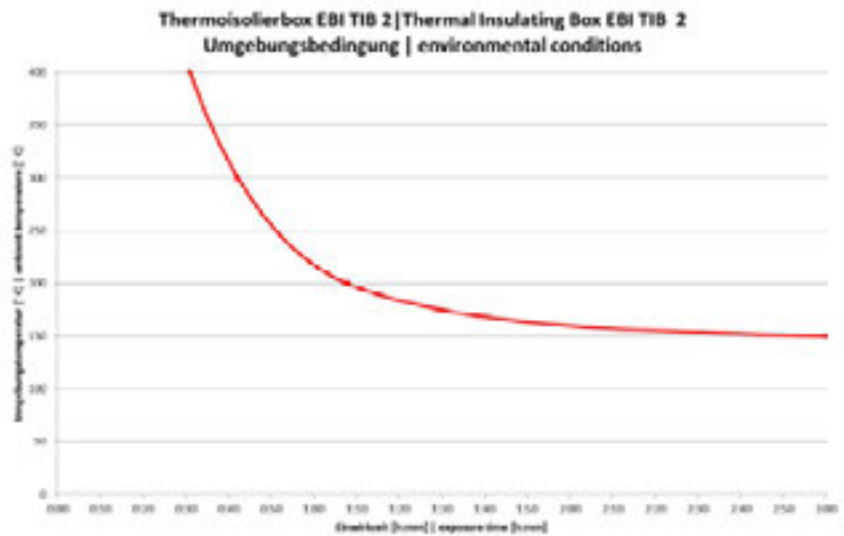

AL 285 **Logger-Check** For thermal measuring system control in steam sterilizer

In combination with the software Winlog.validation the AL 285 offers you a simple functional check of the measuring channels.



EN ISO 17665-1, paragraph 9.1.4

Verification of the calibration value of the measuring instrument that is used for the validation of the sterilization process at process condition.

- Easy and reproducible test with automatic generation of reports.
- The tests are stored permanently in the database





Set SI 1100
for EBI 12 and EBI 11

- 2-port Interface IF 100
- Software Winlog.pro
- USB connection
- Colored LEDs signaling programming, readout and incorrect development



Set SI 1200
for EBI 12

- 4-port Interface IF 200
- Software Winlog.pro
- USB connection
- Colored LEDs signaling programming, readout and incorrect development
- Includes antenna



Set SI 2100
for EBI 12 and EBI 11

- 2-port Interface IF 100
- Software Winlog.med
- USB connection
- Colored LEDs signaling programming, readout and incorrect development



Set SI 2110
for EBI 12

- 4-port Interface IF 200
- Software Winlog.med
- USB connection
- Colored LEDs signaling programming, readout and incorrect development
- Includes antenna



Set SI 2150
for EBI 12 and EBI 16

- 1-port Interface IF 150
- Software Winlog.med
- USB connection
- Colored LEDs signaling programming, readout and incorrect development



Set SI 3200
for EBI 12

- 4-port Interface IF 200
- Software Winlog.validation
- USB connection
- Colored LEDs signaling programming, readout and incorrect development
- Includes antenna



AL 112
for IF100 and IF 200

- Developed for real time monitoring
- AL 112 is a cable with 3 m length
- Antenna placement in the field of the door seal of a sterilizer or washer-disinfector
- Antenna steam-tight
- It is possible by a sealing to introduce it in the chamber



Can adapter set
EBI DA-Set

With this adapter set you can fix the data loggers at cans or plastic bags. Designed for data loggers of the EBI 12 series with axial, radial or external probes. Hereby you assure the use to ensure proper probes placement.



Can adapter EBI DA
for bottle loggers
(see page 14)



Bottle adapter EBI FL-S
silicone
for bottle loggers
(see page 14)



Grommets for sensor fixing EBI NI-140
Allows precise fixation of the logger sensor, with a 3 mm diameter, in cans and glasses.



Compression fitting EBI KV-3
Allows exact positioning of the logger sensor, with a diameter of 3 mm, in glasses (lid).



Dummy bottle

Please find EBI 12-T23X Temperature data logger from page 12.

The dummy bottles can be screwed to the ground. This allows the EBI 12 to be positioned within the bottle.

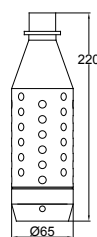

Dummy C

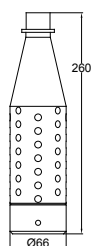

Dummy 0,5 l

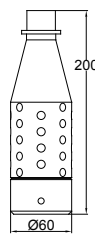

Dummy E

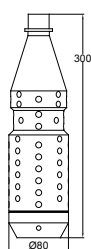

Dummy 1 l

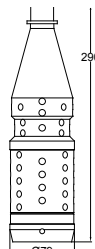

Dummy 0,7 l

Type	Description	Part No.
SI 1100	Set: Interface EBI IF 100 and Software Winlog.pro	1340-6061
SI 1200	Set: Interface EBI IF 200 and Software Winlog.pro	1340-6062
SI 2100	Set: Interface EBI IF 100 and Software Winlog.med	1340-6064
SI 2110	Set: Interface EBI IF 200 and Software Winlog.med	1340-6095
SI 2150	Set: Interface EBI IF 150 and Software Winlog.med	1340-6193
SI 3200	Set: Interface EBI IF 200 and Software Winlog. validation	1340-6068
AL 101	Silicone protection box for EBI 12 Pressure Data Logger	1340-6021
AL 102	Silicone protection box for EBI 12 Temperature Data Logger with 2 radial probes	1340-6022
AL 104	Battery Set for EBI 12	1100-0118
AL 106	Silicone protection box for EBI 12 Temperature Data Logger with 1 radial probe	1340-6023
AL 107	Silicone protection box for EBI 12 Temperature Data Logger with axial probes	1340-6024
AL 111	Replacement antenna for Interface EBI-IF 200	1340-6006
AL 112	Antenna steam sterilizer	1340-6007
AL 120	Battery Replacement Set incl. opening Tool for EBI 12	1100-0130
AL 121	Battery change tool (2 parts) EBI 12	1100-0131
AL 122	Eyelet ring EBI 12	1248-0122
AL 132	Flow adapter for EBI 12-TC 230	1248-0132
AL 190	Silicone cable strap set, consisting of 10 pcs.	1248-0190
AL 285	Logger-Check	1248-0285
EBI TIB2	Thermal Insulation box 160 mm x 160 mm x 60 mm	1340-1892
EBI DA	Can adapter for bottle loggers	1340-1963
EBI DA-Set	Can adapter set for bottle loggers	1340-1984
EBI FL-S	Bottle adapter, silicone	1340-1961
EBI NI-140	Grommets for sensor fixing up to +140 °C (100 pieces)	1340-1988
EBI KV-3	Compression fitting	1340-2005
Dummy C	Dummy Bottle POM 220 mm x 65 mm	1340-2255
Dummy 0,5L	Dummy Bottle POM 0,5 l	1340-2256
Dummy E	Dummy Bottle POM 200 mm x 60 mm	1340-2257
Dummy 1L	Dummy Bottle POM 1 l	1340-2258
Dummy 0,7L	Dummy Bottle POM 0,7 l	1340-2259

Mini Temperature Data Loggers EBI 11 Series

General technical specifications: valid for all EBI 11-T logger types

Operating temperature	-30 °C ... +150 °C (-22 °F ... +302 °F)
Accuracy	±0.2 °C (-30 °C ... +0 °C) ±0.1 °C (0 °C ... +150 °C)
Time accuracy (24h)	< 5 sec
Resolution: temperature	0.01 °C
Data memory	15,000 measurements (total)
Sensor	Pt 1000, Class A
Sampling rate	1 sec ... 24 h
Measurement mode	<ul style="list-style-type: none"> • Endless measurement • Start / Stop measurement • Measure upon start time • Start immediately until end of memory
Storage temperature	-20 °C ... +70 °C (-4 °F ... +158 °F)
Max. operating pressure	20 bar (abs.)
Battery	Lithium button cell, 2 x BR1225 A, 3V, replaceable
Dimensions (Ø x H)	16,5 mm x 24 mm*
Weight	Approximately 45 g *
Housing material	Stainless Steel (V4A)
Protection class	IP68
Certificate	Factory calibration certificate

* Dimensions and weight may be different depending on the type.

Product lines



Data loggers with this symbol are characterized by their very small size. For this reason, they are used in the smallest of spaces, for example to control pasteurization in bottles or to carry out thermal tests in small sterilizers.



Data loggers with this symbol are characterized by their very small size. That is why they are very popular with food manufacturers for testing the effects of temperature during pasteurization.

EBI 11-T210 Mini Temperature Data Logger rigid metal probe



Technical Data

Measurement range: temperature	-30 °C ... +140 °C (-22 °F ... +284 °F)
Data memory	15.000 measurement values
Factory calibration certificate	0 °C, +60 °C and +134 °C

Expected to be available from Q2 2021.

- 1 external temperature probe, axial, pointed, Ø 3 mm
- Probe with M5 external thread

Type	Description	Part No.
EBI 11-T210	Needle Length = 20 mm	1340-6260

EBI 11-T230 to T233 Mini Temperature Data Logger rigid metal probe



Technical Data

Measurement range: temperature	-30 °C ... +150 °C (-22 °F ... +302 °F)
Data memory	15,000 measurement values
Factory calibration certificate	0 °C, +60 °C and +134 °C

- 1 external temperature probe, axial, pointed, Ø 3 mm
- Probe with M5 external thread

Type	Description	Part No.
EBI 11-T230	Needle Length = 20 mm	1340-6290
EBI 11-T231	Needle Length = 50 mm	1340-6292
EBI 11-T233	Needle Length = 100 mm	1340-6293

EBI 11-T235 to T237 **Mini Temperature Data Logger**
rigid metal probe



Technical Data

Measurement range: temperature	-30 °C ... +150 °C (-22 °F ... +302 °F)
Data memory	15,000 measurement values
Factory calibration certificate	0 °C, +60 °C and +134 °C

- 1 external temperature probe, axial, blunt, Ø 1.95 mm
- Probe with M5 external thread

Type	Description	Part No.
EBI 11-T235	Needle Length = 25 mm	1340-6270
EBI 11-T236	Needle Length = 80 mm	1340-6271
EBI 11-T237	Needle Length = 165 mm	1340-6272

EBI 11-T240 **Mini Temperature Data Logger**
bendable metal probe



Technical Data

Measurement range: temperature	-30 °C ... +150 °C (-22 °F ... +302 °F)
Data memory	15.000 measurement values
Factory calibration certificate	0 °C, +60 °C and +134 °C

- 1 external temperature probe, axial, bendable, Ø 1.5 mm

Type	Description	Part No.
EBI 11-T240	Needle Length = 250 mm	1340-6291

Mini Temperature / Pressure Data Loggers EBI 11 Series

General technical specifications: valid for all EBI 11-P logger types

Operating temperature	0 °C ... +150 °C (+32 °F ... +302 °F)
Accuracy: temperature	±0.1 °C (0 °C ... +150 °C)
Accuracy: pressure	±15 mbar (0 mbar ... 4,000 mbar) ±20 mbar (4,000 mbar ... 10,000 mbar)
Time accuracy (24h)	< 5 sec
Resolution: temperature	0.01 °C
Resolution: pressure	1 mbar
Data memory	7,500 measurement values per channel
Sensor: temperature	Pt 1000, Class A
Sensor: pressure	Piezoresistive (temperature compensated)
Sampling rate	1 sec ... 24 h
Measurement mode	<ul style="list-style-type: none"> • Endless measurement • Start / Stop measurement • Measure upon start time • Start immediately until end of memory
Storage temperature	-20 °C ... +70 °C (-4 °F ... +158 °F)
Max. operating pressure	20 bar (abs.)
Battery	Lithium, 2x BR1225A, 3V, user replaceable
Dimensions (Ø x H)	16,5 mm x 48 mm*
Weight	Approximately 45 g *
Housing material	Stainless Steel (V4A)
Protection class	IP68
Certificate	Factory calibration certificate

* Dimensions and weight may be different depending on the type.



EBI 11-P100 Mini Temperature / Pressure Data Logger
internal sensor



Technical Data

Measurement range: temperature	0 °C ... +150 °C (+32 °F ... +302 °F)
Measurement range: pressure	1 mbar ... 10,000 mbar
Data memory	2 x 7,500 measurement values
Factory calibration certificate	0 °C, +60 °C and +134 °C 100 mbar, 3,100 mbar, 6,000 mbar at +25 °C and 3,100 mbar at +134 °C

- 1 internal temperature sensor
- 1 internal pressure sensor

Type	Description	Part No.
EBI 11-P100	Without pressure connector	1340-6295

EBI 11-P111 Mini Temperature / Pressure Data Logger
Luer-Lock connection



Technical Data

Measurement range: temperature	0 °C ... +150 °C (+32 °F ... +302 °F)
Measurement range: pressure	1 mbar ... 10,000 mbar
Data memory	2 x 7,500 measurement values
Factory calibration certificate	0 °C, +60 °C and +134 °C 100 mbar, 3,100 mbar, 6,000 mbar at +25 °C and 3,100 mbar at +134 °C

- 1 internal temperature sensor
- 1 internal pressure sensor

Type	Description	Part No.
EBI 11-P111	Luer-Lock connection	1340-6296

EBI 11-TP110 Mini Temperature / Pressure Data Logger M5 thread connection



Technical Data

Measurement range: temperature	0 °C ... +150 °C (+32 °F ... +302 °F)
Measurement range: pressure	1 mbar ... 10,000 mbar
Data memory	2 x 7,500 measurement values
Factory calibration certificate	0 °C, +60 °C and +134 °C 100 mbar, 3,100 mbar, 6,000 mbar at +25 °C and 3,100 mbar at +134 °C

- 1 internal temperature sensor
- 1 internal pressure sensor

Type	Description	Part No.
EBI 11-TP110	M5 thread	1340-6297

EBI 11-TP210 Mini-Temperature / Pressure Data Logger M5 thread connection



Technical Data

Measurement range: temperature	0 °C ... +140 °C (+32 °F ... +284 °F)
Measurement range: pressure	1 mbar ... 8,000 mbar
Accuracy: temperature	±0.1 °C
Accuracy: pressure	±20 mbar (1 mbar ... 4,000 mbar) ±40 mbar (4,000 mbar ... 8,000 mbar)
Data memory:	2 x 7,500 measurement values
Factory calibration certificate	0 °C, +60 °C and +134 °C 100 mbar, 3,100 mbar, 6,000 mbar at +25 °C and 3,100 mbar at 134 °C

Expected to be available from Q2 2021.

- 1 internal temperature sensor
- 1 internal pressure sensor

Type	Description	Part No.
EBI 11-TP210	Pressure data logger with M5 thread	1340-6265

Accessories for EBI 11 and 12



Set SI 1100
for EBI 12 and EBI 11

- 2-port Interface IF 100
- Software Winlog.pro
- USB connection
- Colored LEDs signaling programming, readout and incorrect development



Set SI 1300
for EBI 11

- 4-port Interface IF 300
- Software Winlog.pro
- USB connection
- Colored LED signalling programming, readout and incorrect development



Set SI 2100
for EBI 12 and EBI 11

- 2-port Interface IF 100
- Software Winlog.med
- USB connection
- Colored LEDs signaling programming, readout and incorrect development



Set SI 3300
for EBI 11

- 4-port Interface IF 300
- Software Winlog.validation
- USB connection
- Colored LED signalling programming, readout and incorrect development





Battery change set AL 113
for EBI 11

Suitable for 3 battery exchanges; contains 6 batteries, 3 O-rings with grease and changing tools.



AL 114 can/bag adapter set
for EBI 11-T230, EBI 11-T231 and EBI 11-T233



Bottle adapter set AL 115
for EBI 11-T230

Battery change set AL 113L
for EBI 11

Suitable for 10 battery exchanges; contains 20 batteries, 10 O-rings with grease and changing tools.

Type	Description	Part No.
SI 1100	Set: EBI IF 100 interface and Winlog.pro software	1340-6061
SI 1300	Set: EBI IF 300 interface and Winlog.pro software	1340-6063
SI 2100	Set: EBI IF 100 interface and Winlog.med software	1340-6064
SI 3300	Set: EBI IF 300 interface and Winlog.validation software	1340-6069
AL 113	Battery changing set for EBI 11	1100-0120
AL 113L	Battery changing set for EBI 11	1100-0125
AL 114	Can / bag adapter set for EBI 11-T230, EBI 11-T231 and EBI 11-T233	1340-6298
AL 115	Bottle adapter set for EBI 11-T230	1340-6299



Validation, Routine and Process control sets

Due to the different requirements for the process control, the routine control and validation of processes, there are different sets at ebro®.

As an example, applications for the different sets are clearly displayed in the table. So, it is possible to choose the set suitable for your application at a glance.

	SL 1011	SL 1111	SL 1521	SL 1621	SL 2002	SL 3001	SL 3101	SL 3111	SL 3302	SL 4002	SL 4021	SL 4102	SL 4121
	1250-1011	1250-1111	1250-1521	1250-1621	1250-2002	1250-3001	1250-3101	1250-3111	1250-3302	1250-4002	1250-4021	1250-4102	1250-4121
Routine control in													
Bedpan washer	✓				✓		✓	✓					
Washer disinfectant		✓		✓	✓		✓	✓	✓				
Endoscope washer disinfectant		✓			✓		✓	✓	✓				
Sterilizer < 60 l		✓	BD *	BD */ ✓	✓	✓	✓	✓	✓				
Sterilizer > 60 l		✓	BD *	BD */ ✓	✓	✓	✓	✓	✓				
Validation of Processes in													
Washer disinfectant				✓	✓		✓	✓	✓				
Endoscope washer disinfectant					✓		✓	✓	✓				
Sterilizer < 60 l					✓	✓	✓	✓	✓				
Sterilizer > 60 l							✓	✓					
DAC Universal									✓				
Process control in													
Pasteurization cans										✓	✓		
Pasteurization bottles												✓	✓

* Bowie&Dick-Test

Data Logger Sets



Complete Data Logger Sets for Process control and Monitoring, for Routine Control, Mapping and Acceptable Quality Limit (AQL)

Description:

- Data Loggers with evaluation software and extensive equipment
- FDA 21 CFR Part 11 conform software

Applications:

- Process control, Monitoring and routine control in steam sterilizers, washer disinfectors, washer disinfectors for endoscopes as well as bedpan washers.
- Implementation of the electronic Bowie&Dick-Test.
- Process and routine control of pasteurization and bottle cleaning processes
- Process and routine control in cooking processes
- Process and routine control in other thermal processes in the food, pharma or medical sector

Advantages:

- Fully automatic and tamper-proof evaluation
- Individual evaluation by user-defined evaluations
- Wide range of wireless data loggers for different applications
- Highly flexible temperature cable probe
- High precision Pt 1000 temperature sensors
- High accuracy up to ± 0.05 °C
- TÜV certified, FDA 21 CFR Part 11 conform software
- 2 years warranty





Complete Data Logger Sets for Operation and Process Qualification

Description:

- Data Loggers for validation with evaluation software and extensive equipment
 - TÜV certified
 - FDA 21 CFR Part 11 conform software
-

Applications:

- Operation and Process Qualification in pasteurization and bottle cleaning processes.
 - Operation and Process Qualification in steam sterilizers, washer disinfectors, washer disinfectors for endoscopes as well as DAC-Universal
 - Operation and Process Qualification in cooking processes
 - Operation and Process Qualification in other thermal processes in the food, pharma or medical sector
-

Advantages:

- Fully automatic and tamper-proof evaluation
 - Individual evaluation by user-defined evaluations
 - Wide range of wireless data loggers for different applications
 - Highly flexible temperature cable probe
 - High precision Pt 1000 temperature sensors
 - High accuracy up to ± 0.05 °C
 - TÜV certified, FDA 21 CFR Part 11 conform software
 - 2 years warranty
-

Data Logger Sets for process and charge control, for routine control, mapping and Acceptable Quality Limit (AQL)

- **EBI 11 Mini Data Logger Sets**

SL 400X: for temperature monitoring in cans (see page 47)
SL 4102: for temperature monitoring in bottles (see page 48)

- **EBI 16 Bowie&Dick-Test Sets**

according to EN 285 / ISO 17665
SL 1521: for steam sterilizers (see page 46)
SL 1621: for steam sterilizers and washer disinfectors (see page 46)

- **EBI 12 Precision Data Logger Sets**

For process and routine control of food and pharma processes as well as medical processes according to the German guideline.
SL 1011: for bedpan washers (see page 44)
SL 1111: for steam sterilizers and washer disinfectors (see page 45)
SL 402X: for temperature monitoring in tins (see page 48)
SL 412X: for temperature monitoring in bottles and cans (see page 49)
SL 4211: for temperature monitoring in different applications (see page 49)

The sets can individually be expanded or compiled yourself from one or more data loggers (EBI 11, EBI 16 or EBI 12), the appropriate interface and the corresponding software. Talk to us!

SL 1011 Temperature Data Logger Set for temperature monitoring and A_0 value calculation in bedpan washers



The set contains:

- 1 x EBI 12-T101 Temperature data logger (see page 11)
- Winlog.med Software
- EBI IF 150 Interface
- Carrying case „SYSTAINER“
- pH & conductivity tester (see page 59)

Type	Description	Part No.
SL 1011	EBI 12 data logger set for bedpan washers	1250-1011

SL 1111 **Temperature / pressure data logger set**
 for temperature and pressure monitoring as well as for A_0 value
 calculation in steam sterilizers, washer disinfectors and washer
 disinfectors for endoscopes



The set contains:

- 1 x EBI 12-TP231 Pressure / temperature data logger with Luer-Lock connection (see page 21)
- AL 101 Silicone protection box
- Winlog.med Software
- EBI IF 150 Interface
- Carrying case „SYSTAINER“
- pH & conductivity tester (see page 59)

Type	Description	Part No.
SL 1111	EBI 12 Data logger set for steam sterilizers and washer disinfectors	1250-1111



SL 1521 EBI 16 Bowie&Dick-Test Set for steam sterilizers certified according to ISO 11140-4



The set contains:

- 1 x Bowie&Dick-Test EBI 16
(see page 27)
- Winlog.med software
- EBI IF 150 interface
- Carrying case „SYSTAINER“

Type	Description	Part No.
SL 1521	EBI 16 Bowie&Dick-Test Set for steam sterilizers	1250-1521

SL 1621 EBI 16 Bowie&Dick-Test and Process Control Set for steam sterilizers and washer disinfectors



The set contains:

- 1 x Bowie&Dick-Test EBI 16
(see page 27)
- 1 x EBI 12-TP231
Temperature / pressure data
logger (see page 21)
- Winlog.med software
- EBI IF 150 interface
- Carrying case „SYSTAINER“

Type	Description	Part No.
SL 1621	EBI 16 Bowie&Dick-Test Set for steam sterilizers and washer disinfectors	1250-1621

SL 400X EBI 11 Mini Data Logger Set for Pasteurization and Sterilization



for temperature monitoring in cans



The set contains:

- 1 x EBI 11-T23x Mini temperature data logger, needle length: 20 mm, 50 mm or 100 mm
- AL 114 can adapter set
- EBI IF 100 interface
- Winlog.pro software
- Carrying case „SYSTAINER“



Type	Needle length:
EBI 11-T230	20 mm
EBI 11-T231	50 mm
EBI 11-T233	100 mm

Type	Description	Part No.
SL 4002	EBI 11-T230 Set for pasteurization and sterilization	1250-4002
SL 4003	EBI 11-T231 Set for pasteurization and sterilization	1250-4003
SL 4004	EBI 11-T233 Set for pasteurization and sterilization	1250-4004

SL 402X EBI 12 Data Logger Set for Pasteurization and Sterilization for temperature monitoring in tins



The set contains:

- 1 x EBI 12-T43X Temperature data logger, needle length: 50 mm, 75 mm, 100 mm or 150 mm
- EBI DA-SET Can Adapter
- EBI IF 100 Interface
- Winlog.pro Software
- Carrying case „SYSTAINER“

Type	Description	Part No.
SL 4021	EBI 12-T430 set for pasteurization and sterilization	1250-4021
SL 4022	EBI 12-T431 set for pasteurization and sterilization	1250-4022
SL 4023	EBI 12-T432 set for pasteurization and sterilization	1250-4023
SL 4024	EBI 12-T433 set for pasteurization and sterilization	1250-4024

SL 4102 EBI 11 Mini Data Logger Set for Pasteurization for temperature monitoring in bottles



The set contains:

- 1 x EBI 11-T230 Mini temperature data logger, needle length: 20 mm
- AL 115 Bottle adapter set
- EBI IF 100 interface
- Winlog.pro software
- Carrying case „SYSTAINER“

Type	Description	Part No.
SL 4102	EBI 11-T230 Mini data logger set for pasteurization	1250-4102

SL 412X EBI 12 Data Logger Set for Pasteurization for temperature monitoring in bottles and cans



The set contains:

- 1 x EBI 12-T46X Temperature data logger, needle length: 135 mm, 190 mm, 245 mm, 270 mm or 300 mm
- EBI FL-S Bottle Adapter
- EBI DA Can Adapter
- EBI IF 100 Interface
- Winlog.pro Software
- Carrying case „SYSTAINER“

Type	Description	Part No.
SL 4121	EBI 12-T461 Data logger set for pasteurization	1250-4121
SL 4122	EBI 12-T462 Data logger set for pasteurization	1250-4122
SL 4123	EBI 12-T463 Data logger set for pasteurization	1250-4123
SL 4124	EBI 12-T464 Data logger set for pasteurization	1250-4124
SL 4125	EBI 12-T465 Data logger set for pasteurization	1250-4125

SL 4211 EBI 12 Basic Temperature Monitoring Set Temperature monitoring system for different applications



The set contains:

- 1 x EBI 12-T101 Temperature data logger
- EBI IF 100 Interface
- Winlog.pro Software
- Carrying case „SYSTAINER“

Type	Description	Part No.
SL 4211	EBI 12 Basic temperature monitoring set	1250-4211

Data Logger Sets for Operation and Process Qualification

- **EBI 11 Mini Data Logger Sets**
SL 3302: Validation set for DAC Universal MK IV (see page 53)
- **EBI 12 Precision Data Logger Sets**
SL 2002: for washer disinfectors (see page 50)
SL 3001: for benchtop sterilizers (see page 51)
SL 3101: for large steam sterilizers (see page 51)

The sets can individually be expanded or compiled by yourself from one or more data loggers (EBI 11, EBI 16 or EBI 12), the appropriate interface and the corresponding software. Talk to us!

SL 2002 Complete Validation Set for washer disinfectors



For the validation of washer disinfectors according to ISO 15883.

The set can individually be expanded or compiled yourself from one or more data loggers (EBI 12 or EBI 11), the appropriate interface and corresponding TÜV certified software. Talk to us!

The set contains:

- 1 x EBI 12-T220 Temperature data logger
- 2 x EBI 12-T441 Temperature data loggers
- 1 x EBI 12-TP231 Temperature/pressure data logger
- 1 x EBI 12-TC230 Temperature/conductivity data logger
- EBI IF 200, 4-port Interface with USB connection and antenna
- Software Winlog.validation
- Carrying case „SYSTAINER“



Type	Description	Part No.
SL 2002	Validation set for washer-disinfectors	1250-2002

SL 3001 Complete Validation Set for benchtop steam sterilizers



For the validation of processes with small steam sterilizers according to ISO 17665.

The set can individually be expanded or compiled yourself from one or more data loggers (EBI 11, EBI 16 or EBI 12), the appropriate interface and corresponding TÜV certified software. Talk to us!

The set contains:

- 1 x EBI 12-TP453 Temperature/ pressure data logger with AL 101 silicone protection box
- EBI IF 200 4-port Interface with USB connection and antenna
- Software Winlog.validation
- Carrying case „SYSTAINER“



Type	Description	Part No.
SL 3001	Validation set for small steam sterilizers	1250-3001

SL 3101 Complete Validation Set with flexible wired probes for large steam sterilizers



For the validation of steam sterilizer processes according to ISO 17665.

The set can individually be expanded or compiled yourself from one or more data loggers (EBI 11 or EBI 12), the appropriate interface and corresponding TÜV certified software. Talk to us!

The set contains:

- 5 x EBI 12-T471 Temperature data loggers with AL 107 silicone protection boxes
- 1 x EBI 12-TP453 Temperature/ pressure data logger with AL 101 silicone protection box
- EBI IF 200, 4-port Interface with USB connection and antenna
- Software Winlog. validation
- 2 x AL 190 silicone cable strap sets
- Carrying case „SYSTAINER“



Type	Description	Part No.
SL 3101	Validation set for large steam sterilizers	1250-3101

SL 3111 Complete Validation Set with bendable metal probes for large steam sterilizers



For the validation of steam sterilizer processes according to ISO 17665.

The set can individually be expanded or compiled yourself from one or more data loggers (EBI 11 or EBI 12), the appropriate interface and corresponding TÜV certified software. Talk to us!

The set contains:

- 5 x EBI 12-T441 Temperature data loggers
- 1 x EBI 12-TP 226 Temperature / pressure data logger with AL 101 silicone protection box
- EBI IF 200, 4-port Interface with USB connection and antenna
- Winlog. validation evaluation software
- Carrying case „SYSTAINER“



Type	Description	Part No.
SL 3111	Validation set for large steam sterilizers	1250-3111

Equipment for operation or process qualification

AL 3305 DAC Adapter Set for validation of the thermal process in DAC UNIVERSAL MK IV

With the Adapter set is an independent process qualification of a DAC Universal MK III and MK IV in combination with ebro EBI 11 data loggers possible. No modification on the customers lid necessary.



Systainer inlay is also prepared for some of adapters AL 3306 to AL 3308 (see page 54)

The set contains:

- 1 x Logger mount
- 1 x PCD test body incl. adapter for ISO, Sirona and KaVo
- Carrying case „SYSTAINER“



Type	Description	Part No.
AL 3305	DAC-Adapter Set	1248-3305

SL 3302 **Complete Validation Set**
 for *DAC UNIVERSAL, small steam sterilizers as well as washer disinfectors*



Very flexible data logger system to perform validations for DAC Universal MK IV according to ISO 15883. This reliable system consists of user-friendly mini data loggers that can be placed directly in the processes and an evaluation software package that has been certified by the TÜV.

The set contains:

- 2 x EBI 11-T235 Mini temperature data logger, needle length: 25 mm
- 2 x EBI 11-T236 Mini temperature data logger, needle length: 80mm
- 1 x EBI 11-P111 Mini pressure data logger
- EBI IF 300, 4-port Interface
- Winlog.validation Software
- Carrying case „SYSTAINER“



Type	Description	Part No.
SL 3302	Validation set for DAC Universal MK IV	1250-3302
EBI 11-T237	additional temperature logger to validate DAC Universal MK III	1340-6272



PCD test body matching to the logger holder for the thermal test and for indicators.

Developed for usage with test soil fittings supplied by SMP GmbH Tübingen.



AL 3304 Central Column for thermal validation of the DAC UNIVERSAL MK IV



AL 3306 - AL 3308 DAC Cleaning adapters for different plugs.



AL 3309 PCD Test Body



AL 3310 Logger holder



AL 3311 Thermal Load simulator

Type	Description	Part No.
AL 3304	Central Column	1248-3304
AL 3306	DAC Cleaning adapter matching to ISO connector	1248-3306
AL 3307	DAC Cleaning adapter matching to Sirona connector	1248-3307
AL 3308	DAC Cleaning adapter matching to KaVo connector	1248-3308
AL 3309	PCD Test Body	1248-3309
AL 3310	Logger holder	1248-3310
AL 3311	Thermal Load simulator	1248-3311

Other additional Accessories

AL 126 Test adapter for hollow bodies and hoses for validation in washer disinfector and endoscope washer



The test adapter offers a simple solution in connection with cleaning indicator (test soil) to perform a routine test in relation to cleaning performance as well as performance qualification during validation processes according to national standards. In addition to AL 126 we recommend also to use a combination of pressure and temperature logger.

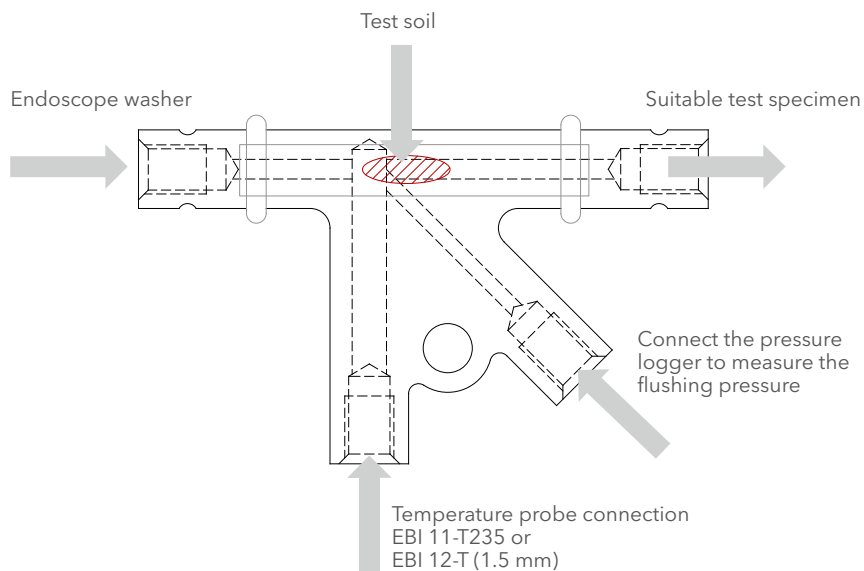

The set contains:

- Test adapter
- Luer-Lock connection to connect a pressure logger
- 2 x Tube adapter 4 mm
- 1 x clamp connection 1.5 mm
- 2 x O-rings for fitting test soil

Type	Description	Part No.
AL 126	Test adapter for hollow bodies, hoses and endoscopes	1248-0126



AL 127 Trolley „SYSTAINER“ for the easy transport of Systainers



For transport of systainers
Fixed seat of the systainers on the trolley

Type	Description	Part No.
AL 127	Trolley „Systainer“	1248-0127

AL 128 Carrying Case



Technical Data

Housing	ABS
Dimension (L x W x D)	105 mm x 396 mm x 296 mm
Weight	1.3 kg

- Combined
- Modular construction
- Loggers are safely stored

Type	Description	Part No.
AL 128	Carrying Case	1248-0128

Suitable Inlays for AL 128

Type	Description	Part No.
AL 1100	Inlay for EBI 12 and interface especially for validation sets	1248-1100
AL 1101	Inlay for EBI 12 and silicone protection boxes	1248-1101
AL 1102	Inlay for EBI 16 and interface IF 150	1248-1102
AL 1103	Inlay for EBI 11 or EBI 12 and interface especially for pasteurization	1248-1103
AL 1105	Inlay for EBI 11 and interface especially for DAC Set	1340-6096-0001
AL 1106	Inlay for PHT 830 or CT 830	1340-6096-0003
AL 1107	Inlay for 7 pcs. of EBI 12 data loggers	1340-6096-0009
AL 1108	Inlay for small parts	1340-6096-0010

Adequate pH- and Conductivity Meters for Validation Sets

PHT 830 pH Meter with temperature compensation



- Configuration directly on device using 5 buttons and display
- Graphic LCD display with backlight
- Logging function
- Temperature compensated
- Software connection by IF 830, Winlog.pro, Winlog.med, Winlog.validation

Calibration solutions on page 56

Technical Data

Measurement range	pH:	0 pH ... 14 pH
	mV:	-1,999 ... 1,999 mV
	temperature:	-10 °C ... +100 °C
Resolution	pH:	0.01 pH;
	mV:	1 mV
	temperature:	0.1 °C
Accuracy	pH:	± 0.03 (± 2 pH-units)
	temperature:	± 0.1 °C
Memory		4,000 measurement values
Temperature		-10 °C ... +100 °C
Display		128 x 64 pixel, backlight
Interface		USB with "Interface HMG USB", galvanically isolated
Battery		3 Batteries Type AA, IEC R6, LR6, 1.5 V
Ambient		-10 °C ... +55 °C
Relative humidity		Max. < 95 % (not condensating)
Connections		Connectors BK (4-pin interface socket)
Housing		ABS
Protection class		IP65
Dimension (L x W x D)		200 mm x 95 mm x 40 mm
Weight		290 g incl. Batteries

CT 830 Conductivity Meter with auto range



- Configuration directly on device using 5 buttons and display
- Graphic LCD display with backlight
- Logging function
- Temperature compensated
- Software connection by IF 830, Winlog.pro, Winlog.med, Winlog.validation

Technical Data

Measurement range	0 ... 200 µS/cm	TDS 0 ... 200 mg/l
	0 ... 2,000 µS/cm	TDS 0 ... 2,000 mg/l
Resolution	0.1 µS/cm; 1 µS/cm	
Accuracy	conductivity:	± 0.5 % of the measuring range
	temperature:	± 0.1 °C
Memory		4,000 measurement values
Temperature		-10 °C ... +100 °C
Display		128 x 64 pixel, backlight
Interface		USB with "Interface HMG USB", galvanically isolated
Battery		3 Batteries Type AA, IEC R6, LR6, 1.5 V
Ambient		-10 °C ... +55 °C
Relative humidity		< 95 % (not condensating)
Connections		Connectors BK (4-pin interface socket)
Housing		ABS
Protection class		IP65
Dimension (L x W x D)		200 mm x 95 mm x 40 mm
Weight		290 g incl. Batteries

Type	Description	Part No.
PHT 830 SET 1	pH Meter with plastic electrode	1340-5812
CT830 SET	Conductivity Meter with plastic electrode	1340-5835

Various electrodes for PHT 830



AT 830 pH K Binder
Temperature compensated

- Housing material: plastic
- Cable length: 150 cm
- Diameter: 12 mm
- Shaft length: 120 mm



**AT 830 pH G Binder,
laboratory electrode**
Temperature compensated

- Shaft housing material: glass
- Cable length: 100 cm
- Shaft diameter: 12 mm
- Shaft length: 120 mm



**AT 830 pH E Binder,
penetration electrode**
Temperature compensated
for measurements in semi-solid food products and other materials.

- Housing material: glass
- Cable length: 100 cm
- Shaft/electrode diameter: 15 mm/5 mm
- Shaft/electrode length: 65 mm/12 mm

Technical Data	AT 830 pH K	AT 830 pH G	AT 830 pH E
pH measurement range	0 pH ... 14 pH	0 pH ... 14 pH	2 pH ... 13 pH
Temperature measurement range	0 °C ... +100 °C (+32 °F ... +212 °F)	0 °C ... +100 °C (+32 °F ... +212 °F)	+5 °C... +80 °C (+41 °F... +176 °F)
Electrolyte	Gel	Gel	Referid®

Type	Description	Part No.
AT 830 pH K Binder	Plastic electrode	1339-0661
AT 830 pH G Binder	Measurement electrode for laboratories	1339-0662
AT 830 pH E Binder	Penetration electrode	1339-0663

Electrode for CT 830



AT 830 C Binder
Temperature compensated

- Housing material: plastic
- Cable length: 150 cm
- Diameter: 12 mm
- Shaft length: 120 mm

Technical Data	AT 830 C
Conductivity measurement range	0 µS/cm ... 500 mS/cm
Temperature measurement range	0 °C ... +100 °C (+32 °F ... +212 °F)

Type	Description	Part No.
AT 830 C Binder	Plastic electrode	1339-0660

Calibration and Buffer solutions



Buffer bottles
Standard (DIN/NIST) buffer solutions

Type	Description	Part No.
PL 4	Standard (DIN / NIST) buffer solution, pH 4,006 - 250ml	109110
PL 7	Standard (DIN / NIST) buffer solution, pH 6,865 - 250 ml	109120
PL 9	Standard (DIN / NIST) buffer solution, pH 9,180 - 250 ml	109130
KCI-250	Reference electrolyte, KCl-solution 3 mol/l - 250 ml	109705
E-Set Trace	Calibration Standard, 0.01 mol/KCl (6x 50 ml)	300572

Interface cable for PHT 830 and CT 830

EBI IF 830

For reading out the memory of the PHT 830 and CT 830

- Software connection
Winlog.pro, Winlog.med,
Winlog.validation



Type	Description	Part No.
EBI IF 830	Interface for PHT 830 and CT 830	1340-6011

PHX 800 Basic pH Tester with acoustic signal



- Automatic deactivation
- Battery charge indicator
- Replaceable battery

Technical Data

pH measurement range	0 pH ... 14 pH
pH measurement accuracy	0.1 pH
pH resolution	±0.2 pH
Operating temperature	0 °C ... +50 °C (+32 °F ... 122 °F)
Storage temperature	-25 °C ... +60 °C (-13 °F ... 140 °F)
Housing material	ABS plastic
Protection class	IP65
Dimension (L x W x H)	170 x 32 x 15 mm
Weight	Approximately 70 g
Battery	1.5 V A76/LR44
Battery lifetime	Approximately 150 hours
Deactivation	Automatically after 15 minutes

Type	Description	Part No.
PHX 800	Basic pH Tester	1340-5800

TDS 3 Basic Conductivity Tester Dual Display



- Battery charge indicator
- Replaceable battery

Technical Data

Measurement range	0 ... 1,999 µS	0 ... 1,999 ppm
	0 ... 19.99 mS	0 ... 19.99 ppt
Measurement accuracy	1 µS	
Resolution	1 µS	
Operating temperature	0 °C ... +50 °C (+32 °F ... 122 °F)	
Storage temperature	-25 °C ... +60 °C (-13 °F ... 140 °F)	
Housing material	ABS plastic	
Protection class	IP67	
Dimension (L x W x H)	170 x 32 x 15 mm	
Weight	Approximately 70 g	
Battery	4 x 1.5 V A76/LR44	
Battery lifetime	Approximately 150 hours	

Type	Description	Part No.
TDS 3	Basic Conductivity Tester	1340-5831

Process Monitoring



EBI 25
Wireless Data Logger System



EBI 40
Multi-Channel Temperature
Data Logger

Description:

- Radio data logger system for temperature and humidity measurements
- Other measurements can be integrated using Modbus over IP or other protocols
- Automatic alarm when limit is exceeded
- Automatic report generation

Applications:

- Continuous monitoring of Food in cooling or freezing areas, Drugs and vaccine in Drug Stores, clinical trials in labs and in Warehouses

Description:

- Temperature data logger for up to 6 or 12 thermocouple sensors with SMP connection
- Current measurement values and measurement curve shown on multi-color TFT display
- With USB connection for fast programming and readout of the measurement data

Applications:

- Monitoring of food in cooling or freezing areas, drugs and vaccine in drug stores, clinical trials in labs and in warehouses





EBI 310 PDF Data Logger

Description:

- Multi-use data loggers for temperature and humidity measurement
- USB connection
- Automatic PDF report generation with all measurement data
- Easy programming of the data loggers via the free online configurator at www.ebi310.com, no special software required

Applications:

- Monitoring of food in cooling or freezing areas, drugs and vaccine in drug stores, clinical trials in labs and in warehouses

EBI 40 Multi-Channel Temperature Data Logger

The EBI 40 Multi-Channel Temperature Data Logger records temperatures during process monitoring and validation. Current measurement values and the measurement curve can be read on the multi-colored TFT display. The thermal insulation using the thermo isolation box allows the use of the data logger at very high temperatures. The EBI 40 is suitable for the connection of up to six or twelve thermocouple probes.

Applications:

Monitoring and validation of processes in:

- Incubators
- Refrigerators
- Climate cabinets
- Storage rooms
- Transport studies
- Freeze-dryers etc.



EBI 40-TC Multi-Channel Data Logger for type K and T thermocouple sensors



Technical Data

Measurement range	-200 °C ... +1,200 °C (-328 °F ... +2,192 °F)
Accuracy*	±0.5 °C (at +25 °C)
Resolution	0.1 °C (0.2 °F)
Channels	6 or 12 temperature channels
Sampling rate	Adjustable from 0.1 sec to 24 hours
Sensor	Thermocouple Type K or Type T / SMP connection
Operating temperature	0 °C ... +60 °C (0 °F ... +140 °F)
Storage temperature	0 °C ... +70 °C (+32 °F ... +158 °F)
Memory	20,000 measurements per channel (max. 240,000 measurements)
Measurement mode	<ul style="list-style-type: none"> • Endless measurement immediatley • Measure immediatley until end of memory • Start / stop measurement
Display	TFT-display 3.5" (324 x 240 Pixel)
Dimensions (L x W x H)	140 x 118 x 35 mm
Housing material	ABS + PC
Protection class	IP40
Certificate	Factory Calibration Certificate

* The accuracy of the used probe adds to the accuracy of the device.
E.g. probes with class 1 of IEC 584 have +/- 0,5 °C between -40 °C ... +125 °C.

Matching probes can be found
online at www.ebro.com

Type	Description	Part No.
EBI 40-TC-01	6-channel data logger (without probes)	1340-6400
EBI 40-TC-02	12-channel data logger (without probes)	1340-6401

Accessories for EBI 40



Similar to photo

EBI TIB 400-01 Thermal Isolation Box for EBI 40
Sturdy thermal barrier (stainless steel and ceramic)

- Heat resistant insulation
- Replaceable sealing and cooling element
- Easy to transport
- Protects EBI 40 for 2 hours at +250°C (+482 °F)
- Dimensions (with folded handles): 247 x 210 x 131 mm



AN 141 Adapter cable, 1 m silicone (SMP/Lemo size 0)



AN 142 Extension cable, 1 m silicone, SMP

AN 144 Extension cable, 2.5 m, silicone, SMP



Wall mount **EBI 40-WH** Bracket for 35 mm cap rail

Type	Description	Part No.
TPN 611-3	Flexible Thermo Wire Probe up to +400 °C, 3 m, SMP	1343-0800-0100
AN 142	Extension cable, 1 m silicone, SMP	1343-2626
AN 144	Extension cable, 2.5 m silicone, SMP	1343-2627
EBI TIB 400-01	Thermal Isolation Box for EBI 40	1340-6430
EBI 40-WH	EBI 40 wall mount	1340-6431

EBI 25 Wireless Data Logger System

The EBI 25 system for wireless monitoring of temperature, humidity and other measurements assures that perishable goods are produced and stored at the right conditions at all times. Other measurements can be integrated using Modbus over IP.

Benefits:

- Continuous monitoring
- Avoid loss of goods
- Quick intervention before it is too late
- Automatic documentation
- Worldwide access to the measurement data
- Easy handling, user replaceable battery



Embedding of other measurements possible:

- Differential pressure
- CO₂
- Particles
- Power demand
- Many others

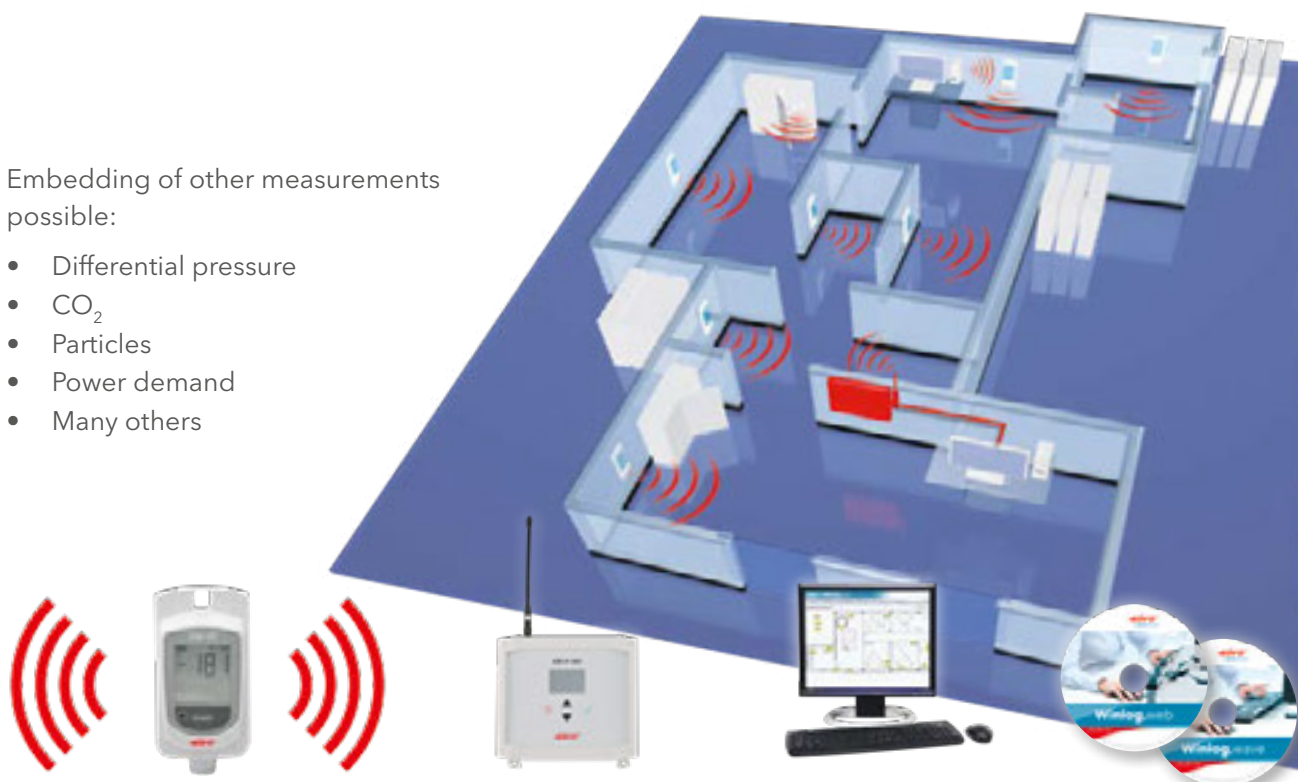

EBI 25 data loggers

- Precise measurement of temperature and humidity (depends on logger type)
- Very large range of up to 500 m in a free field
- Max. Range of 100 m in buildings (depending on the building fabric)
- Long battery lifetime
- Easy installation

Base station: IF 400 interface

- Collects and stores the data of all connected EBI 25 data loggers
- Connection of up to 50 loggers per interface possible
- Stores up to 576 measurements per logger
- Direct connection of any number of interfaces to a PC or the network
- Audible alarm (with optional alarm box)

Evaluation software:

Winlog.web and Winlog.wave

Winlog.wave: Basic version for local PC usage.

Winlog.web: Professional version for internet and local network based use.

Please find more information from page 84.

General technical specifications: valid for all EBI 25 data logger types*

Resolution: temperature	0.1 °C (0.2 °F) in a range of -99.9 °C ... +199.9 °C (-147.8 °F ... +391.8 °F) 1 °C (2 °F) of the remaining measurement range
Resolution: humidity (humidity data loggers only)	0.1 % rH
Memory	288 measurement values (per channel)
Sampling rate	1 min. to 24 hours, adjustable
Radio frequency	868 MHz in EU
Battery	3.6 V lithium (user replaceable)
Battery lifetime	Up to 2 years, depending on measurement and transmission rate
Storage temperature	-40 °C ... +85 °C (-40 °F ... +185 °F)
Operating temperature	-30 °C ... +60 °C (-22 °F ... +140 °F)
Measurement mode	Endless measurement
Housing material	ABS
Weight	Approximately 65 g

* Please find the exact technical data of each EBI 25 data logger type on the next pages.

EBI 25-T Wireless Temperature Data Logger with internal temperature sensor



Technical Data

Measurement range	-30 °C ... +60 °C (-22 °F ... +140 °F)
Accuracy	±0.5 °C at -20 °C ... +40 °C (±0.9 °F at -4 °F ... 104 °F) ±0.8 °C (±1.4 °F) for the remaining measurement range
Sensor	NTC
Protection class	IP67
Dimensions (L x W x H)	95 x 48 x 27 mm
Factory Calibration Certificate	-20 °C and 0 °C

Type	Description	Part No.
EBI 25-T	Wireless temperature logger (with internal sensor)	1340-6200A

EBI 25-TE Wireless Temperature Data Logger with external probe



Technical Data

Measurement range	-40 °C ... +85 °C (-40 °F ... +185 °F)
Accuracy	±0.5 °C -20 °C ... +40 °C (±0.9 °F at 4 °F ... 104 °F) ±0.8 °C -30 °C ... -20 °C / +40 °C ... +60 °C (±1.4 °F at -22 °F ... -4 °F / +104 °F ... +140 °F) ±1.5 °C -40 °C ... -30 °C / +60 °C ... +85 °C (±2.7 °F at -40 °F ... -22 °F / +140 °F ... +185 °F)
Sensor	NTC
Probe	Ø 3.8 mm, L = 65 mm, with 2 m PUR cable
Protection class	IP67
Dimensions (L x W x H)	95 x 48 x 27 mm (without probe)
Factory Calibration Certificate	-20 °C and 0 °C

Type	Description	Part No.
EBI 25-TE	Wireless temperature logger (with external probe)	1340-6201A

EBI 25-TX Wireless Temperature Data Logger for high and low temperatures



Technical Data

Measurement range	-200 °C ... +199.9 °C (-328 °F ... +391.8 °F)
Accuracy*	±2 °C (-200 °C ... -100 °C) ±0.5 °C (-100 °C ... -20 °C and +60 °C ... +199.9 °C) ±0.4 °C (-20 °C ... +60 °C)
Probe	Ø 5 mm, L = 50 mm, with 3 m PTFE cable
Probe connection	Binder, series 620
Sensor	Pt 1000
Protection class	IP67
Dimensions (L x W x H)	135 x 48 x 27 mm (without probe)
Factory Calibration Certificate	-80 °C, 0 °C and +134 °C

*Accuracy only applies when using an adjusted probe

Type	Description	Part No.
EBI 25-TX	Temperature data logger (with probe TPX 25-3)**	1340-6204A
EBI 25-TX	Temperature data logger (without probe)	1340-0025
TPX 25-3	Pt 1000 probe for EBI 25-TX, 3 m	1341-0025
TPX 25-5	Pt 1000 probe for EBI 25-TX, 5 m	1341-0026
TPX 25-7,5	Pt 1000 probe for EBI 25-TX, 7,5 m	1341-0027
TPX 25-10	Pt 1000 probe for EBI 25-TX, 10 m	1341-0028

** Calibration certificate valid only for logger and probe.

EBI 25-TH Wireless Temperature / Humidity Data Logger with external humidity sensor



At www.ebro.com you will find matching filter caps for sensor protection.

Technical Data

Measurement range: temperature	-30 °C ... +60 °C (-22 °F ... +140 °F)
Measurement range: humidity	0 % rH ... 100 % rH
Accuracy: temperature	±0.5 °C -20 °C ... +40 °C (± 0.9 °F at -4 °F ... 104 °F) ±0.8 °C (±1.4 °F) for the remaining measurement range
Accuracy: humidity	±3 % rH (10 % ... 90 %)
Sensor	NTC for temperature / capacity humidity sensor
Protection class	IP20
Dimensions (L x W x H)	124 x 48 x 27 mm (with probe)
Factory Calibration Certificate	0 °C and +20 °C

Type	Description	Part No.
EBI 25-TH	Wireless temperature / humidity logger	1340-6202A
AH 100	PTFE filter for EBI 25-TH	1340-5627
AH 300	Stainless steel sintered filter for EBI 25-TH	1340-5625

Sets and Accessories for EBI 25



AL 250 - Protection Box for EBI 25 TE and TX

Protects the data logger from hose water, as it is the case when cleaning production sites.

Delivery Contents:
Incl. Mounting material, drill template, holder for EBI 25 logger.

Technical Data

Protection Class	IP67
Dimensions (L x W x H)	170 x 80 x 68 mm



EBI 2 AB-2 - Alarmbox to connect to interface IF 400

If you prefer to be informed about a violation of the limit, close the alarm box to the IF 400 base station. Depending on the setting in the software, you will receive an alarm via this base station or the loggers.

The alarm box has a potential-free changeover contact which is used to connect additional devices for alarming.

Delivery Contents:
Incl. Mounting material

Technical Data

Supply Voltage	100 to 250 V AC
max. switched power	8A, 30V DC / 250V AC
Dimensions (L x W x H)	120 x 80 x 55 mm



AL 251 - orange Flash Light and buzzer combination

You can connect the LED / buzzer combination to the potential-free contact of the alarm box for visual alarm in case of limit violations.

Delivery Contents:
Power supply and connection cable are not included.

Technical Data

Supply Voltage	24 V DC
loudness	92 dB
Protection Class	IP65
Dimensions (L x W x H)	120,5 x 91 x 91 mm



EBI IF 400 - Interface for EBI 25 data logger

The interface works as a communication interface between EBI 25 data logger and software Winlog.wave or Winlog.web

Delivery Contents:
Antenna, Power Supply, USB-cable.

Technical Data

Protection Class	IP20
Dimensions (without Antenna) (L x W x H)	150 x 180 x 45 mm
Operating Temperature	-25 °C ...+50 °C
USB-Connection	Typ B 100 mA USB 1.1
LAN-Connection	Ethernet 10 / 100



AG 152 - Wall Mount for EBI 25 data logger

The AG 152 is used for simple and secure attachment of the EBI 25 data loggers.

Delivery Contents:
Logger fastening, Opening tool, Mounting material (double sided tape, screws, dowel, cable ties).

Technical Data

Material	ABS
Dimensions (L x W x H)	150 x 180 x 45 mm



AL 116 - external Antenna to connect with IF 400

Install the antenna in the wet area and increase the range.

Delivery Contents:
Mounting material (screws / dowel).

Technical Data

Cable length	3 m
Dimensions (L x W)	110 x 255 mm

Type	Description	Part No.
AG 152	Wall Mount for EBI 25 data logger	1340-6215
AL 250	Protection Box for EBI 25 TE and TX	1248-0250
EBI 2 AB-2	Alarm box to connect with interface IF 400	1613-1301
AL 251	Orange Flash Light and Buzzer combination	1340-6233
AL 252	Power supply 24V for AL 251 Flash Light	1220-0355
EBI IF 400	Interface for EBI 25 data logger	1340-6210
AL 116	External Antenna	1340-6211
AL 120 PS	Power supply 12 V for Interface IF 400 - for replacement	1220-0350
Winlog.web	Web based Evaluation Software - Server solution	1340-2390
Battery	Battery for EBI 25 data logger	1100-0121

EBI 310 PDF Data Loggers

Cold Chain Monitoring

The easy to use data loggers with USB connection monitor the temperature and/or humidity during transport and storage of sensitive goods like medicine, food, serums etc. Measurement reports are created automatically as PDF files when you connect the logger to a PC.

The EBI 310 PDF data loggers are well suited for mappings e.g. of warehouses to identify critical temperature spots.



Program | Measure

- Programming of the logger with the help of the free online configurator at **www.ebi310.com** or optionally via the ebro software Winlog.basic or Winlog.pro
- Set optional limits and start to record the measurement data

Connect | Readout

- Connection of the logger to any PC via the USB port
- Automatic generation of a PDF report with all important measurement data

Evaluate | Archive

- Store, save or email the PDF report
- Further processing of the measurement data with the software Winlog.basic or Winlog.pro

Benefits

- Direct USB connection
- Automatic PDF report generation
- Programmable at **www.ebi310.com**, no special software for programming and readout required but available
- Indication of alarm status via flashing LED
- Data integrity
- Conforms with FDA 21 CFR Part 11 and ATP
- The data loggers help you to comply with GMP and VO (EG) 37/2005
- Free firmware updates at your place via software
- Excellent value-for-money



Digital interface

- Digital interface between loggers and external probes (at EBI 310 TE, EBI 310 TH and EBI 310 TX).
- Data logger functions as data collector with optional internal sensor
- Easy exchange of the external probes e.g. for calibration: remove and send probe, connect replacement probe, measure!
- No calibration of the data collector required, if internal probe is not used!

Which EBI 310 PDF data logger is the right one for your application?

Every EBI 310 PDF data logger has the afore mentioned properties. Depending on the application, claim and your purse, there are different requirements for which we have the right devices. The following overview shall help making the decision.

	EBI 310	EBI 310 TE	EBI 310 TX	EBI 310 TH
Applications				
Monitoring of deep temperatures		✓	✓*	
Monitoring of high temperatures		✓	✓*	
Humidity monitoring				✓
Storage monitoring	✓	✓	✓*	✓
Transport monitoring	✓	✓	✓*	✓
Process monitoring		✓	✓*	✓
Usage within dry ice				
Measurement channels				
Internal temperature channel	✓	✓	✓	✓
External temperature channel		1	2 *	1
Sensor cable		✓	✓*	
High precision (Pt 1000)	✓	✓	✓	✓
Humidity channel				✓
Usage				
Multi-use	✓	✓	✓	✓
Calibration certificate				
Including factory calibration certificate	✓	✓	✓*	✓
Other features				
Display	✓	✓	✓	✓
Very flexible alarms (5 limits and MKT)	✓	✓	✓	✓
High memory capacity (120,000 measurements)	✓	✓	✓	✓

* with connected, exchangeable sensors

General technical specifications: valid for all EBI 310 data logger types*

Memory capacity	120,000 measurements
Alarm	5 ranges
PDF creation	PDF/A 1b
LED	Yes (red and yellow)
Storage temperature	-40 °C ... +85 °C (-40 °F ... +185 °F)
Sample rate	1 s ... 24 h
Measurement modes	<ul style="list-style-type: none"> • Endless measurement • Start / Stop • Measurement until end of memory • Start with key press
Display	Value, MIN / MAX, until end of memory, alarm on / off
Maximum start delay	72 h
Housing material	Polycarbonate
Certificate	Factory calibration certificate
Norms	DIN EN 12830

* Please find the exact technical data of each EBI 310 data logger type on the next pages.

EBI 310 Multi-Use PDF Data Logger
High precision version



Technical Data

Measurement range/operating temperature	-30 °C ... +75 °C (-22 °F ... +167 °F) <i>By connecting an external probe, the temperature measurement range can be extended.</i>
Accuracy	±0.2 °C (-30 °C ... +30 °C / -22 °F ... +86 °F) ±0.5 °C for the remaining measurement range
Sensor	PT 1000
Resolution	0.1 °C
Dimensions (L x W x H)	80 x 33 x 14 mm
Protection class	IP65
Battery	Lithium button cell (CR 2450), 3 V
Battery lifetime	Up to 2 years, depending on applications
Factory calibration certificate	-20 °C, 0 °C and +60 °C

Type	Description	Part No.
EBI 310	High Precision PDF Data Logger	1340-6331A

Accessories for the EBI 310, EBI 310 TE, EBI 310 TX and EBI 310 TH



EBI 300-WM2 Wall Mount for EBI 310



EBI 300 WM3 transportation mount for EBI 310 made of stainless steel

Type	Description	Part No.
EBI 300-WM2	Wall Mount for EBI 310	1340-6341
EBI 300 WM3	Transportation mount for EBI 310	1340-6344

EBI 310 TE Multi-Use PDF Data Logger with external precision temperature probe

Measurement of high and low temperatures



EBI 310 TE

- Simultaneous measurement of core temperature and ambient temperature
- Internal temperature probe usable additionally

Technical Data

Measurement range external temperature	-200 °C ... +250 °C (-328 °F ... +482 °F)
Measurement range internal temperature / operating temperature	-30 °C ... +75 °C (-22 °F ... +167 °F)
Accuracy (internal)	± 0.2 °C (-30 °C ... +30 °C / -22 °F ... +86 °F) ± 0.5 °C for the remaining measurement range
Accuracy (external)	± 2.0 °C (-200 °C ... -100 °C / -328 °F ... -148 °F) ± 1.0 °C (-100 °C ... -20 °C / -148 °F ... -4 °F) ± 0.2 °C (-20 °C ... +60 °C / -4 °F ... +160 °F) ± 0.5 °C (+60 °C ... +250 °C / +160 °F ... +482 °F)
Probe	Pt 1000, Stainless steel, Ø 5 mm, L = 50 mm, blunt
Cable	PTFE, L = 1 m, waterproof, oilproof and food safe
Resolution	0.1 °C
Dimensions (L x W x H)	91 x 33 x 14 mm
Protection class	IP65
Battery	Lithium button cell (CR 2450), 3V
Battery life time	Up to 2 years, depending on applications
Factory calibration certificate	-80 °C, 0 °C, +60 °C and +134 °C

Type	Description	Part No.
EBI 310 TE	PDF Data logger with external precision temperature probe	1340-6337A
TPX 220	Replacement probe for EBI 310 TE	1341-6332A
TPX 220-3	Replacement probe with 3 m cable for EBI 310 TE	1341-6332-0100A



EBI 310 TH Multi-Use PDF Data Logger with external humidity and temperature probe

Relative humidity monitoring in storages and during transports



EBI 310 TH

Technical Data

Measurement range temperature / operating temperature	-30 °C ... +75 °C (-22 °F ... +167 °F)
Accuracy (internal)	± 0.2 °C (- 30 °C ... + 30 °C / -22 °F ... +86 °F) ± 0.5 °C for the remaining measurement range
Accuracy (external)	± 0.5 °C (0 °C ... + 60 °C / +32 °F ... +140 °F) ± 0.8 °C for the remaining measurement range
Probe temperature	Pt 1000
Measurement range humidity	0 % rH ... 100 % rH
Accuracy humidity	± 2 % between 10 % rH ... 90 % rH (at 25 °C / +77 °F) ± 4 % for the remaining measurement range
Probe humidity	capacitive
Resolution temperature	0.1 °C
Resolution humidity	0.1 % rH
Dimensions (L x W x H)	129 x 33 x 14 mm
Protection class	IP20
Battery	Lithium button cell (CR 2450), 3V
Battery life time	Up to 2 years, depending on applications
Factory calibration certificate	0 °C and +20 °C; 32.8 % and 75.4 % rH

You can find suitable filter caps for humidity sensors online at www.ebro.com

- Internal temperature probe usable additionally

Type	Description	Part No.
EBI 310 TH	PDF Data logger with external humidity probe	1340-6336A
TPH 500	Replacement probe for EBI 310 TH	1341-6337A
AH 100	PTFE filter	1340-5627
AH 300	Stainless steel sintered filter	1340-5625

EBI 310 TX Multi-Use PDF Data Logger with temperature-two-channel-adapter

Temperature monitoring in storages and during transport, process monitoring



EBI 310 TX



exchangeable sensors

Technical Data

Measurement range external temperature	-200 °C ... + 400 °C (-328 °F ... +752 °F), dependent on probe type
Measurement range internal temperature / operating temperature	-30 °C ... +75 °C (-22 °F ... +167 °F)
Accuracy (internal)	± 0.2 °C (- 30 °C ... + 30 °C / -22 °F ... +86 °F) ± 0.5 °C for the remaining measurement range
Probe	Pt 1000
Resolution	0.1 °C
Dimensions (L x W x H)	111 x 33 x 14 mm
Protection class	IP65
Battery	Lithium button cell (CR 2450), 3V
Battery life time	Up to 2 years, depending on applications
Factory calibration certificate	-200 °C, 0 °C and +400 °C

- Up to two exchangeable probes can be connected; not included, see the following page
- Internal temperature probe usable additionally

Type	Description	Part No.
EBI 310 TX	PDF Data logger with temperature-two-channel-adapter	1340-6339A
TPX 310	Replacement adapter for EBI 310 TX	1341-6335A

Exchangeable probes for EBI 310 TX

**TPX 310-P1**

- Measurement range: -200 °C ... +200 °C (-328 °F ... +392 °F)
- Needle: L = 45 mm, Ø = 5 mm, blunt
- Cable: PTFE, L = 3 m

Temperature		Accuracy
-200...-100 °C	-328...-148 °F	1.7 °C
-100...-20 °C	-148...-4 °F	1.2 °C
-20...+60 °C	-4...+140 °F	1.0 °C
+60...+200 °C	+140...+392 °F	1.7 °C

**TPX 310-P2**

- Measurement range: -50 °C ... +180 °C (-58 °F ... +356 °F)
- Needle: L = 130 mm, Ø = 3 mm, blunt
- Cable: PTFE, L = 3 m

Temperature		Accuracy
-50...+60 °C	-58...+140 °F	0.6 °C
+60...+180 °C	+140...+356 °F	0.9 °C

**TPX 310-P3**

- Measurement range: -50 °C ... +180 °C (-58 °F ... +356 °F)
- Needle: L = 130 mm, Ø = 3 mm, blunt
- Cable: PTFE, L = 1 m

Temperature		Accuracy
-50...+60 °C	-58...+140 °F	0.5 °C
+60...+180 °C	+140...+356 °F	0.8 °C

**TPX 310-P4**

- Measurement range: +100 °C ... +400 °C (+212 °F ... +752 °F)
- Needle: L = 50 mm, Ø = 1.5 mm, blunt
- Cable: metal wrapped, L = 3 m, not waterproof

Temperature		Accuracy
+100...+250 °C	+212...+482 °F	1.1 °C
+250...+400 °C	+482...+752 °F	1.4 °C

**TPX 310-P5**

- Measurement range: -50 °C ... +180 °C (-58 °F ... +356 °F)
- Probe: L = 130 mm, Ø = 3 mm, blunt
- Cable: PTFE, L = 5 m

Temperature		Accuracy
-50...-20 °C	-58...-4 °F	0.5 °C
-20...+60 °C	-4...+140 °F	0.6 °C
+60...+180 °C	+140...+356 °F	0.8 °C

**TPX 310-P6**

- Measurement range: -50 °C ... +180 °C (-58 °F ... +356 °F)
- Probe: L = 130 mm, Ø = 3 mm, blunt
- Cable: PTFE, L = 7.5 m

Temperature		Accuracy
-50...+60 °C	-58...+140 °F	0.7 °C
+60...+180 °C	+140...+356 °F	1.0 °C

**TPX 310-P7**

- Measurement range: -50 °C ... +180 °C (-58 °F ... +356 °F)
- Probe: L = 130 mm, Ø = 3 mm, blunt
- Cable: PTFE, L = 10 m

Temperature		Accuracy
-50...+60 °C	-58...+140 °F	0.9 °C
+60...+180 °C	+140...+356 °F	1.1 °C

Type	Description	Part No.
TPX 310-P1	External sensor for EBI 310 TX	1341-6338
TPX 310-P2	External sensor for EBI 310 TX	1341-6339
TPX 310-P3	External sensor for EBI 310 TX	1341-6340
TPX 310-P4	External sensor for EBI 310 TX	1341-6341
TPX 310-P5	External sensor for EBI 310 TX	1341-6342
TPX 310-P6	External sensor for EBI 310 TX	1341-6343
TPX 310-P7	External sensor for EBI 310 TX	1341-6344

www.EBI310.com appears in a new design



Easy to Use!



Start



Connect



Inspect

Information

About Data Logger and Applications.

Configuration

Configure your PDF- data logger and program it by using Windows™ PC.

Simple and clear

Also usable with smartphone or Tablet.



Software

ebro® offers exactly the software you need:

- Evaluation software for any applications:
Winlog.pro
- Evaluation software for EBI 25 data loggers:
Winlog.web
- Evaluation software for pharmaceutical and medical applications:
Winlog.med and Winlog.validation

Software/Features	Winlog.pro	Winlog.med	Winlog.validation	Winlog.web
Event Triggered Recording	●	●	●	●
Script-Calculations	●			●
System-Scripts	●			
Picture Manager	●		●	
Measure in Charts	●			
Cursor	●	●	●	
Realtime Calculations	●	●	●	●
Ranges	●	●	●	
Range-based Calculations	●	●	●	
Statistics per Range	●	●	●	
Relative Time Axis	●			
Configurations	●	●(2)	●(2)	
Firmware-Update	●	●	●	●
Import	●(1)			
Calibration	●	●	●	
Automatic File Name Generation	●			
21 CFR Part 11	●	●	●	●
User Administration	●	●	●	●
Audit-Trail	●	●	●	●
Advanced Chart Features	●			
Multi Document Support	●	●	●	
Export (Excel, PDF)	●	●	●	●
Customizable Company Logo	●	●	●	●
Wireless Support	●	●	●	●
2D Placement	●		●	●
3D Placement			●	
Routine Check	●(3)	●	●	
Validation	●(3)		●	
Unit Administration	●	●	●	●
Split Measurements	●	●	●	
Advanced Alarm-Management (Zones)	●(5)			
IQ/OQ	●		●	●

(1) Winlog.validation
(2) Template based

(3) Manual
(4) Since V2.5
(5) EBI 310 only

(6) Since V2.6
(7) Since V3.3
(8) Since V3.5

(9) Since V2.8
(10) Since V3.7



Supported Logger Types	Winlog.pro	Winlog.med	Winlog.validation	Winlog.web
EBI 10	●	●	●	
EBI 11	●	●	●	
EBI 12	●(9)	●(10)	●(10)	
EBI 16		●(8)	●(8)	
EBI 20	●	●(7)	●(7)	
EBI 25				●
EBI 40	●	●(7)	●(7)	
EBI 100	●	●	●	
EBI 310	●(6)	●(7)	●(7)	
CT 830	●	●	●	
PHT 830	●	●	●	

System Requirements	Winlog.pro	Winlog.med	Winlog.validation	Winlog.web
Windows 8 / 32 bit	●	●	●	●
Windows 8 / 64 bit	●	●	●	●
Windows 10 / 32 bit	●	●	●	●
Windows 10 / 64 bit	●	●	●	●
Memory	≥ 1GB	≥ 2 GB (32bit) / ≥ 4 GB (64bit)	≥ 2 GB (32bit) / ≥ 4 GB (64bit)	≥ 4 GB
Hard Disc Memory	≥ 1GB	≥ 4 GB	≥ 4 GB	≥ 20 GB
DVD Drive	●	●	●	●
Screen Resolution	≥ 1280x768	≥ 1280x768	≥ 1280x768	≥ 1280x768
Processor	Dual Core 1.6 GHz+	Dual Core 1.6 GHz+	Dual Core 1.6 GHz+	Dual Core 2 GHz+

Market Overview	Winlog.pro	Winlog.med	Winlog.validation	Winlog.web
Food	●			●
Industry	●		●	●
Pharmaceutical	●		●	●
Medical	●	●	●	●

Available Languages	Winlog.pro	Winlog.med	Winlog.validation	Winlog.web
English	●	●	●	●
French	●	●	●	●
Italian	●	●	●	●
Spanish	●	●	●	●
Chinese	●	●	●	●
Japanese	●	●	●	
Korean	●	●	●	
Portuguese		●	●	
Greek		●	●	
Czech	●	●	●	●
Swedish	●	●	●	
Dutch	●	●	●	
German	●	●	●	●
Turkish		●	●	
Polish		●	●	
Norwegian		●	●	

Simplification and support in qualifying the measurement system

Advantages

- Easy installation
- Simple programming of the data loggers, no prior knowledge necessary
- Extensive and customer specific generation of reports
- Suitable for all applications
- Safety through FDA 21 CFR Part 11 conformity

You can buy those to the particular software type additionally.

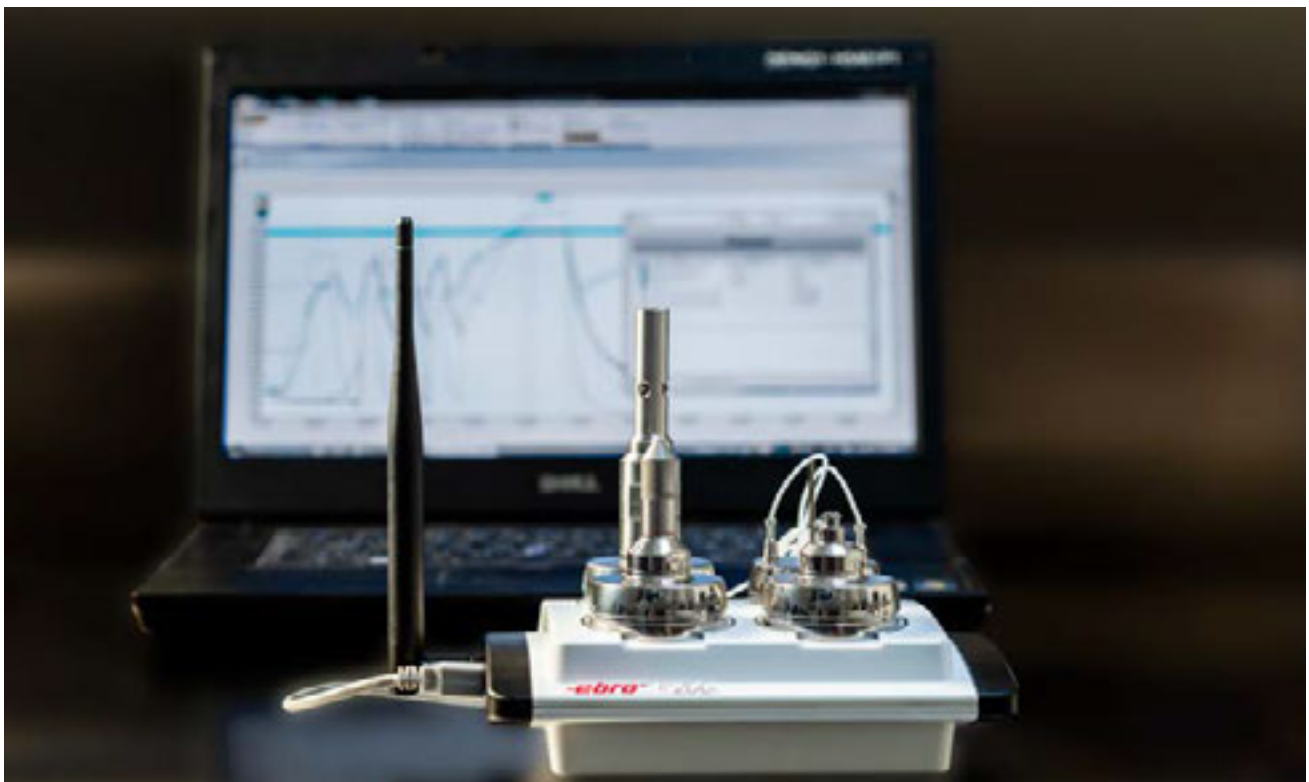

Design Qualification (DQ)

It is generally necessary to determine for which application a device or measurement instrument is being bought. The Design Qualification proves this exactly. At the same time it has to be noticed which departments have to be taken into account during the purchase.

Installation Qualification (IQ)

After deciding for a type of measurement device it has to be put into operation. Therefore, different examinations have to be done. Firstly, the Installation Qualification is necessary. During this phase it is being examined whether all parts which are important for the installation are there and suit the appropriate requirements. Afterwards steps relevant to the system during the installation will be documented. By using the IQ a safe installation is guaranteed. The system is now ready to use.

Operation Qualification (OQ)

Now the examination takes place to see if the ebro measurement system works how you want it to. During the Operation Qualification all relevant work or measurement steps are being examined and documented. The Operation Qualification tests all functions of the system carefully. After a successful Operation Qualification the system is ready to use.

Process Qualification (PQ)

The end of the system Qualification is the Process Qualification. During the Process Qualification all parameters for the specific measurement tasks are being set, examined and documented. For easy use and support during the Qualifying of the measurement system we offer IQ / OQ documents in the formats word and excel. You can order the respective IQ / OQ documents to the particular software types. (see following pages)

Available for:



Evaluation Software for Any Applications

Winlog.pro

For the programming and reading of ebro® data loggers and for the evaluation of the measured values, ebro® offers the professional software **Winlog.pro**.

Benefits

- Easy installation
- Easy programming of the data loggers, no prior knowledge required
- Extensive and custom report generation
- Suitable for all applications
- Security by compliance with FDA 21 CFR Part 11

Extensive Report Generation

The software makes it easy to generate standard and custom reports:

- Compact, one-sided report (1)
- Multi-page, detailed report (2)
- Tabular report with the measurement values (3)
- Insertion of your own company logo possible (4)
- Export data to Microsoft Excel® and PDF (5)
- Integration of pictures and graphics possible (Winlog.pro only) (6)

(1)

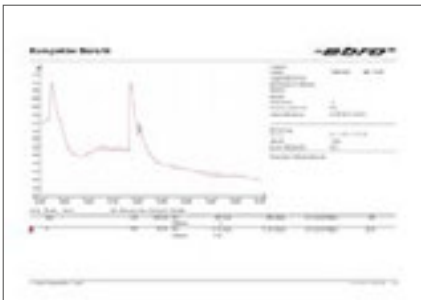

(3)

(5)

(2)

(4)

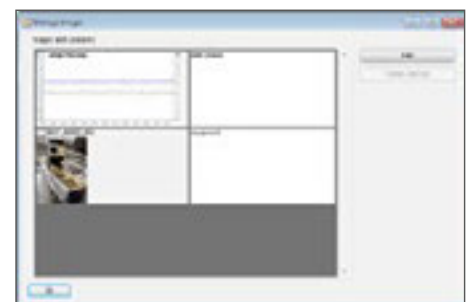

(6)



Winlog.pro Professional software



- Enables real-time monitoring with wireless data loggers
- Formula editor for calculating the F0-value of the absolute humidity, the PE value etc.
- Display of the timeline either absolute or relative
- Customized definition of individual areas possible (with their own statistics and calculations)
- Including calibration tool for data loggers
- Integration of pictures and graphics into reports possible
- IQ/OQ documentation to qualify the system is available



System Requirements

So that the software can run on your computer without any problems, your computer must meet the following requirements:

Hardware Requirements:

- At least 1 GHz processor speed
- At least 1 GB working memory
- At least 1 GB free hard disc space
- USB (Universal Serial Bus)

Software requirements:

- Operating system Microsoft®
- Windows 8 (32 Bit and 64 Bit)
- Windows 10 (32 Bit and 64 Bit)

Type	Description	Part No.
Winlog.pro	Professional evaluation software	1340-2355
IQ/OQ Winlog.pro	Installation and Operation Qualifications for Winlog.pro	1340-2286

Evaluation Software for EBI 25 Data Loggers

Winlog.web

For programming and readout of EBI 25 data loggers as well as for evaluating the measurement values. The software automatically collects and evaluates data and alerts if necessary.

Functionality

The innovative EBI 25 system monitors wirelessly, transmits the data in real time to an interface (base station) and from there to the desired server or PC.

As soon as a temperature, humidity or any other measurement has exceeded a user defined limit, an alarm is immediately sent via email.

Please find the EBI 25 Data Logger Family starting on page 64.

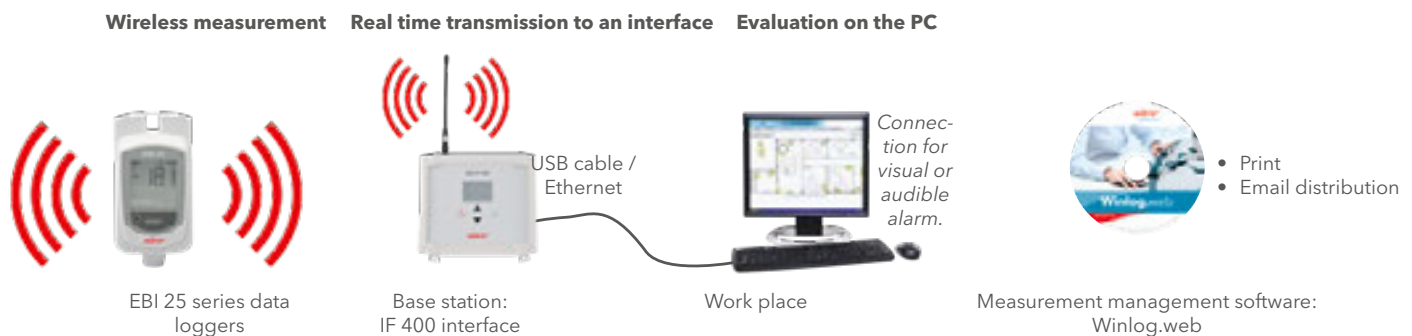

Quick graphical overview of all measurement points including an image or floor plan view:





Winlog.web

Professional version internet and local network based use



- Web based client/server solution: the measurement data can be evaluated on all PCs and smartphones via the internet or connected to the local network
- Very flexible and wide alarm management: alarm notifications upon user defined conditions, alarm notification via email; visual and audible alarm via the graphical user interface
- Connection of the interface IF 400 via USB and Ethernet
- FDA 21 CFR Part 11 data security functionality
- Management of larger data sets
- IQ / OQ documentation to qualify the system is available

System Requirements

To enable the software to operate smoothly, your computer must meet the following requirements:

Hardware requirements:

- Processor speed minimum 2 GHz
- Working memory 4 GB
- 20 GB free hard disc space
- USB 2.0

Software requirements:

- Operating System Microsoft®
- Windows 8 (32 Bit and 64 Bit)
- Windows 10 (32 Bit and 64 Bit)

Further requirements:

- Mozilla Firefox 30 or higher
- Microsoft® Internet Explorer 11
- Google Chrome Version 40 or higher



Type	Description	Part No.
Winlog.web	Evaluation software (web-based server version)	1340-2390
IQ/OQ Winlog.web	Installation Qualification and Operation Qualification for Winlog.web	1340-2290

TÜV certified evaluation Software for Pharmaceutical and Medical Applications

Winlog.med and Winlog.validation

The Winlog.med and Winlog.validation software versions are suitable for programming and readout of ebro data loggers as well as for evaluating the measurement values. The software guides you step by step through the validation or routine control process and evaluates the measurement automatically.

Flexible Report Generation

Whether you need a short process report or a table report with all measurement data - ebro's Winlog software makes it easy.

Table report

Detailed result overview

Process parameters, e.g. theoretical steam temperature calculation

Lethality report

Equipment used

Graphical data

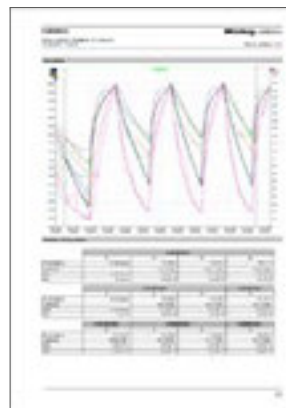

Statistical data



Winlog.med *For routine controls*



- TÜV certified
- User-friendly
- High precision measurements
- Automatic report generation
- Automatic user-defined calculations
- Automatic identification of process cycles
- Creation of user-defined masters for specific devices and thermal processes
- Three-dimensional demonstration of sensor placement or placement of the sensors directly on an application image possible
- FDA 21 CFR Part 11

Winlog.validation *For routine control and validation*



Powerful report and evaluation software fitting the requirements of validation and qualification in Pharmaceuticals and Medicine.

- TÜV certified
- User-friendly
- Central user administration in local area network possible
- Automatic report generation
- Automatic user-defined calculations
- Automatic identification of process cycles
- Creation of user-defined masters for specific devices and thermal processes
- Three-dimensional demonstration of sensor placement or placement of the sensors directly on an application image possible
- FDA 21 CFR Part 11
- Incl. IQ- / OQ-Documentation for software Qualification
- Automatic evaluation of validation processes

System Requirements

To enable the software to operate smoothly, your computer must meet the following requirements:

Hardware requirements:

- Processor speed minimum 1 GHz
- Working memory 1 GB
- 1 GB free hard disc space
- USB (Universal Serial Bus)

Software requirements:

- Operating System Microsoft®
- Windows 8 (32 Bit und 64 Bit)
- Windows 10 (32 Bit und 64 Bit)



Type	Description	Part No.
Winlog.med	Standard evaluation software for routine controls	1340-2363
Winlog.validation	Professional evaluation software for routine controls and validations	1340-2394

Calibration

Precision measurement and testing equipment such as thermometers and data loggers should be checked and calibrated regularly.

Factory Calibration

Most ebro® measuring equipment is supplied with a factory calibration certificate. The functionality and the tolerances indicated in the technical specifications are thus ensured. Factory calibration is completed with traceable factory etalons according to DIN EN ISO / IEC 17025.

- The calibration is carried out at metrological monitored equipment.
- All factory certificates issued by trained personnel.
- The factory calibration certificate confirms the suitability of the device for official calibration.



Calibration according to ISO 9000

Modern quality assurance systems like ISO 9000, QS 9000, GxP and FDA require testing and measuring equipment checks, which also include a regular calibration of these devices. ebro® ISO calibration is an economical, fast and precise option for the fulfillment of these requirements.

- The calibration is carried out by specialized professionally trained calibration technicians.
- The results are documented in detail, including traceability information of the reference devices, in an ISO certificate.
- Manufacturer-independent calibration, devices from other manufacturers can be calibrated by prior arrangement.
- Calibration also includes device adjustment, if necessary (only for ebro® devices).

We recommend the recalibration for thermometers and pressure meters once per year and for humidity meters every 6 months.

The price for the calibration according to ISO 9000 includes certificate and **2 specified standard calibration points**. Freely selectable calibration points between -90 °C and +400 °C (-130 °F ... +752 °F) are available for a small fee.

The calibration of temperature / humidity loggers includes 2 to 3 humidity calibration points in the price. In addition, a temperature calibration in the range of -40 °C ... +75 °C (-40 °F ... 167 °F) can be completed. As found and as left calibrations can be done on demand.

ISO Calibrations



Series	Description	Part No.
	ISO Calibration ¹⁾ at ...	
EBI 12, EBI 11 Temperature data logger	3 temperature points	1030-2203
	4 temperature points	1030-2204
	5 temperature points	1030-2205
EBI 12, EBI 11 Temperature plus another measurand data logger (Pressure, Humidity, Conductivity)	3 temperature points + another measurand	1030-2223
	4 temperature points + another measurand	1030-2224
	5 temperature points + another measurand	1030-2225
EBI 20, EBI 25, EBI 300, EBI 310, EBI 40 Temperature data logger	2 temperature points	1030-2302
	3 temperature points	1030-2303
	4 temperature points	1030-2304
EBI 20, EBI 25, EBI 300, EBI 310 Temperature plus another measurand data logger	2 temperature points + another measurand	1030-2322
	3 temperature points + another measurand	1030-2323
	4 temperature points + another measurand	1030-2324
Handhelds (TFX, TFE, TFN, TLC, TFI, GFX, TTX, TFH, FOM, CT, PHT, VAM)	3 points	1030-2403
	4 points	1030-2404
	5 points	1030-2405

ISO calibrations of other devices on request.

¹⁾ According to DIN ISO 9000 including certificate.

Measurement method	Standard calibration points
Liquid bath (for devices with a resolution of 0.1 °C)	-80 °C, -20 °C, 0 °C, +20 °C, +60 °C, +120 °C, +121 °C, +134 °C, +170 °C, +250 °C
Liquid bath (for devices with a resolution less than 0.1 °C)	-80 °C, -20 °C, 0 °C, +60 °C, 121 °C, 134 °C
Dry block calibrator	+350 °C
Surface calibrator	+50 °C, +100 °C, +200 °C
Black body calibrator (calibration of non-contact infrared thermometers)	0 °C, +60 °C
relative humidity in climatic chamber	32,8 %rH, 52,9 %rH, 75,4 %rF at 25 °C

- Certified according to DIN EN ISO 9001 : 2015

Accredited calibration according to DAkkS guidelines

Accredited calibration according to DAkkS guidelines is often needed for working standard measuring equipment, measuring equipment used by certified experts and for certain measurement procedures in medicine and pharmaceuticals - in other words, everywhere where an especially high degree of safety is required. This calibration is done by special accredited laboratories that are monitored by the Deutsche Akkreditierungsstelle (DAkkS).

- Internationally recognized and comparable measurement results.
- The calibration is carried out by specialized, professionally trained calibration technicians whose competence has been confirmed by the DAkkS.
- Traceable calibration in accordance with DIN EN ISO 9001 and DIN EN ISO/IEC 17025.
- Determination and documentation of the measurement uncertainty for each calibration point of a calibration item.

We recommend the recalibration for thermometers and pressure meters once per year and for humidity meters every 6 months.

The price for accredited calibration according to DAkkS specifications including a calibration certificate includes a number of freely selectable temperature points and, in the case of a calibration of the relative humidity, **3 freely selectable calibration points**. We offer calibrations in the temperature range from -90 °C ... +300 °C, in the range of relative humidity from 10% ... 95% and an absolute pressure from 0 bar ... 25 bar.

With a pressure calibration, the device is calibrated at 9 points. The calibration points cover the entire measuring range. Calibration takes place at room temperature, is between +20 °C and +25 °C. We are happy to calibrate your device at more than 5 temperature points.

Accredited calibration according to DAkkS guidelines



- Accredited calibration according to DAkkS guidelines of other devices on request.

Series	Description	Part No.
	Accredited calibration ²⁾ at ...	
EBI 12, EBI 11	3 temperature points	1030-3203
Temperature data logger	4 temperature points	1030-3204
	5 temperature points	1030-3205
EBI 12, EBI 11,	3 temperature points plus other	1030-3223
Temperature plus another measurand data logger (abs. pressure, rel. humidity)	4 temperature points plus other measurand	1030-3224
	5 temperature points plus other measurand	1030-3225
EBI 20, EBI 25, EBI 300, EBI 310, EBI 40 Temperature data logger	2 temperature points	1030-3302
	3 temperature points	1030-3303
	4 temperature points	1030-3304
EBI 20, EBI 25, EBI 300, EBI 310 Temperature/ Humidity data logger	2 temperature points + humidity	1030-3322
	3 temperature points + humidity	1030-3323
	4 temperature points + humidity	1030-3324
Handhelds (TFX, TFE, TFN, TLC, GFX, TTX, TFH)	3 points	1030-3403
	4 points	1030-3404
	5 points	1030-3405

²⁾ According to DAkkS and traceable to international etalons (PTB, NIST).

Calibration conditions for different calibrations

Temperature Calibrations

Calibration type	Calibration object	Measurement range	Measurement conditions
ISO	Temperature measurement devices with air and submersible sensors, Temperature data logger	-90 °C ... +400 °C (-130 °F ... +752 °F) +250 °C ... +1,000 °C (+482 °F ... 1,832 °F)	Temperature-regulated Liquid baths, Calibration source
DAkks / DKD	Temperature measurement devices resistance thermometers, electronic thermometers and data loggers	0 °C (+32 °F) 0.01 °C (32.018 °F) -90 °C ... -35 °C (-130 °F ... -31 °F) -35 °C ... +250 °C (-31 °F ... +482 °F) +250 °C ... +300 °C (+482 °F ... +572 °F) -85 °C ... +200 °C (-121 °F ... +392 °F) +200 °C ... +300 °C (+392 °F ... +572 °F)	Ice point Water triple point Liquid bath Liquid bath Liquid bath Liquid bath Liquid bath
	Thermocouple	+200 °C ... +300 °C (+392 °F ... +572 °F)	Liquid bath

Surface Temperature Calibrations

Calibration type	Calibration object	Measurement range	Measurement conditions
ISO	Temperature measurement devices with surface probe	+40 °C ... +200 °C (+104 °F ... +392 °F)	Surface calibrator
ISO	Non-contact IR Temperature measurement devices	-35 °C ... +190 °C (-31 °F ... +374 °F)	Black emitter

Humidity Calibrations

Calibration type	Calibration object	Measurement range	Measurement conditions
ISO	Measurement devices for relative humidity	10 % ... 50 % 50 % ... 95 % Temperature range: +5 °C ... +70 °C (+41 °F ... +158 °F)	Two pressure humidity generator Temperature range: +5 °C to +70 °C (+41 °F to +158 °F)
DAkks / DKD	Measurement devices for relative humidity	10 % ... 30 % 30 % ... 70 % 70 % ... 95 % Temperature range: +5 °C ... +70 °C (+41 °F ... +158 °F)	Two pressure humidity generator Temperature range: +5 °C to +70 °C (+41 °F to +158 °F)

Pressure Calibrations

Calibration type	Calibration object	Measurement range	Measurement conditions
ISO	Absolute pressure	0 mbar ... 10,000 mbar	Pressure calibrator
DAkks / DKD	Absolute pressure	0 mbar ... 5,000 mbar >5,000 mbar ... 25,000 mbar	In gases In gases

ISO Standard Calibration Points for ebro Products

Measurement device	Calibration points		
EBI 310 / EBI 300	-20 °C (-4 °F)	0 °C (+32 °F)	+60 °C (+140 °F)
EBI 310 TH	32,8 % at +25 °C (+77 °F) 0 °C (+32 °F)	+20 °C (+68 °F)	75,4 % at +25 °C (+77 °F)
EBI 12 T (depends on device type)	0 °C (+32 °F)	+60 °C (+140 °F)	+134 °C (+273.2 °F)
EBI 12 TP (depends on device type)	100 mbar at +25 °C (+77 °F) 0 °C (+32 °F)	3,100 mbar at +25 °C (+77 °F) +60 °C (+140 °F)	3,100 mbar at +134 °C (+273.2 °F) +134 °C (+273.2 °F)
EBI 20 / EBI 25 (depends on device type)	-20 °C (-4 °F)	0 °C (+32 °F)	
Thermometer with penetration probe	0 °C (+32 °F)	+60 °C (+140 °F)	+120 °C (+248 °F)
Thermometer with surface probe	+50 °C (+122 °F)	+100 °C (+212 °F)	+200 °C (+392 °F)
Thermometer without probe	-100 °C (-148 °F)	0 °C (+32 °F)	+200 °C / +1,000 °C (+392 °F / +1,832 °F)



More than 100 distributors worldwide – find one near you at:
www.ebro.com/en/worldwide

Declarations



Hereby we declare

Xylem Analytics Germany Sales
GmbH & Co. KG, ebro
Peringerstraße 10
85055 Ingolstadt, Germany
Phone: +49 841 95478-0
Fax: +49 841 95478-80

that the following product

Product type:	Data logger
Type designation:	EBI 310

is in compliance with the essential requirements and other relevant provisions of Directive 37/2005 EC.

The following harmonized standards have been used:

- **Tests, performance, suitability: EN 12830**
- **Periodic verification and calibration: EN 13486**

Estewan Preißing, Head of Research & Development, ebro

Conditions of Delivery and Payment

January 2018. Changes reserved. Please find the latest version on our website: www.ebro.com/en/agb

1. APPLICATION

Except as otherwise expressly agreed in writing, these conditions ("**General Conditions**") shall exclusively apply to all deliveries and services of XYLEM Analytics Germany Sales GmbH & Co. KG (in the following: Contract). Deviating conditions of the Purchaser shall not apply.

2. MINIMUM NET ORDER VALUE, VALIDITY OF QUOTATIONS, CUSTOM MADE PRODUCTS, EXCESS DELIVERIES AND CANCELLATION OF ORDERS, TRANSFER OF RISK

2.1 The minimum net order value amounts to EUR 100. For orders below this amount Supplier reserves the right to charge handling costs of EUR 20.

2.2 Quotations are valid for thirty (30) calendar days from the date of issuance unless otherwise agreed in writing by Supplier, subject to prior sale. Supplier reserves the right to cancel or withdraw the quotation at any time with or without notice or cause prior to acceptance by the Purchaser. Supplier nevertheless reserves its right to accept any contractual documents received from the Purchaser after this 30-day period.

2.3 The price for custom made products shall be separately agreed between the Parties.

2.4 Supplier shall have the right to deliver an excess quantity of up to 10% that has to be paid by Purchaser.

2.5 If the Purchaser fully or partly cancels an order for non-custom made products without justification Supplier shall be entitled, notwithstanding the right to assert a higher damage that has actually been incurred due to the cancellation, to demand 10% of the sales price for the cancelled order volume as compensation for the processing and minimum loss of profits unless Purchaser establishes proof of a lower damage. The cancellation or amendment of an order for custom made products shall not be possible.

3. PRODUCT INFORMATION

All information and data contained in general product documentation and price lists, whether in electronic or any other form, are binding only to the extent that they are by reference expressly included in the Contract.

4. DRAWINGS AND DESCRIPTIONS

4.1 All drawings and technical documents relating to the Product or its manufacture submitted by one party to the other, prior or subsequent to the formation of the Contract, shall remain the property of the submitting party.

4.2 Drawings, technical documents or other technical information received by one party shall not, without the consent of the other party, be used for any other purpose than that for which they were provided. They may not, without the consent of the submitting party, otherwise be used or copied, reproduced, transmitted or communicated to a third party.

4.3 Supplier shall, not later than at the date of delivery of Products, provide free of charge information and drawings which are necessary to permit the Purchaser to erect, commission, operate and maintain the Product. Such information and drawings shall be supplied in the number of copies agreed upon or at least one copy of each. Supplier shall not be obliged to provide manufacturing drawings for the Product or for spare parts.

5. INSPECTIONS AND TESTS

5.1 Inspections

5.1.1 If expressly agreed in the Contract, the Purchaser shall be entitled to have the quality of the materials used and the parts of the Product, both during manufacture and when completed, inspected and checked by its authorised representatives. Such inspection and checking shall be carried out at the place of manufacture during normal working hours after agreement with Supplier as to date and time, and at the Purchaser's expense.

5.2 Tests

5.2.1 Acceptance tests provided for in the Contract shall, unless otherwise agreed, be carried out at the place of manufacture during normal working hours.

5.2.2 If the Contract does not specify the technical requirements, the tests shall be carried out in accordance with the Supplier's standard practice.

5.2.3 If the Purchaser in due time has requested in writing, Supplier shall notify the Purchaser in writing of the acceptance tests in sufficient time to permit the Purchaser to be represented at the tests. If the Purchaser is not represented, the test report shall be sent to the Purchaser and shall be accepted as accurate. With regard to standard products (as defined by Supplier from time to time) only a "production card" will be delivered with the Product stating that the Product has passed the

test procedure and thereby is approved. If requested by the Purchaser in writing and prior to the performance of the test, a test report will be sent to the Purchaser at an additional cost reasonably determined by Supplier.

5.2.4 If the acceptance tests show the Product not to be in accordance with the Contract, Supplier shall without delay remedy any deficiencies in order to ensure that the Product complies with the Contract. New tests shall then be carried out at the Purchaser's request, unless the deficiency in Supplier's sole opinion was insignificant.

5.2.5 Supplier shall bear all costs for acceptance tests carried out at the place of manufacture. The Purchaser shall however bear all costs and expenses for its representatives in connection with such tests. The Purchaser shall bear all costs for any optional tests requested by the Purchaser.

6. DELIVERY, PASSING OF RISK

6.1 Any agreed trade term shall be construed in accordance with INCOTERMS 2010. If no trade term is specifically agreed, the delivery ("**Delivery**") shall be DAP, Purchaser's address as set out in the Purchaser's purchase order accepted by Supplier. However, Supplier's costs for DAP delivery shall be paid by Purchaser as set out in Clause 9.6 below.

6.2 Partial shipments shall be permitted unless otherwise agreed.

7. TIME FOR DELIVERY

7.1 Time for Delivery

If the Parties, instead of specifying the date for Delivery, have specified a period of time on the expiry of which Delivery shall take place, such period shall start to run as soon as the Contract is entered into, all official formalities have been completed, payments due at the formation of the Contract have been made, any agreed securities have been given and any other preconditions have been fulfilled.

7.2 Delay on part of Supplier

7.2.1 Any time periods specified by Supplier in the Contract for Delivery are to be treated as estimates whilst the Supplier shall make reasonable efforts to deliver on time. If Supplier anticipates that it will not be able to deliver the Product at the time for Delivery ("**Delay**"), Supplier shall inform the Purchaser thereof and, if possible, the time when Delivery can be expected.

7.2.2 If Delay is caused by any of the circumstances mentioned in Clause 14 or by an act or omission on the part of the Purchaser, including suspension under Clauses 9.4 or 14, the time for Delivery shall be extended by a period which is reasonable having regard to all the circumstances in the case. This provision applies regardless of whether the reason for the Delay occurs before or after the agreed time for Delivery.

7.2.3 In case of Delay, the Purchaser may in writing demand delivery within a final reasonable period which shall not be less than ninety (90) days from the Supplier's receipt of such demand. If Supplier does not deliver within such final period and this is not due to any circumstance for which the Purchaser is responsible or a Delay covered by Clauses 7.3 or 14, then the Purchaser may by notice in writing to Supplier terminate the Contract in respect of such part of the Product that cannot, in consequence of Supplier's failure to deliver, be used as intended by the Parties.

THE PURCHASER SHALL IN NO EVENT BE ENTITLED TO ANY LIQUIDATED DAMAGES IN THE CASE OF DELAY.

7.2.4 If the Purchaser terminates the Contract due to Delay, it shall be entitled to compensation for the loss it has suffered as a result of Supplier's Delay. The total compensation shall not exceed, except in cases of intent or gross negligence, 10 percent of that part of the purchase price which is attributable to the part of the Product in respect of which the Contract is terminated.

7.3 Delay on part of the Purchaser

7.3.1 If the Purchaser anticipates that it will be unable to accept Delivery of the Product at the Delivery time, it shall forthwith notify Supplier in writing thereof, stating the reason and, if possible, the time when it will be able to accept Delivery.

7.3.2 If the Purchaser for any reason fails to accept Delivery at the Delivery time, it shall nevertheless pay any part of the purchase price which becomes due on Delivery, as if Delivery had taken place. Supplier shall arrange for storage of the Product at the risk and expense of the Purchaser. Any other direct and/or financial costs incurred as a result of such failure to accept Delivery shall be borne by the Purchaser. Supplier shall, if the Purchaser so requires in writing, insure the Product on behalf of the Purchaser and at the Purchaser's expense.

7.3.3 Unless the Purchaser's failure to accept Delivery is due to any such circumstance as mentioned in Clause 14, Supplier may by notice in writing require the Purchaser to accept Delivery within a final reasonable period.

7.3.4 If, for any reason for which Supplier is not responsible, the Purchaser fails to accept Delivery within such period, Supplier may by notice in writing terminate the Contract in whole or in part. Supplier shall then be entitled to compensation for the loss it has suffered by reason of the Purchaser's default. The compensation shall not exceed that part of the purchase price which is attributable to that part of the Product in respect of which the Contract is terminated.

8. ALTERATIONS AND CANCELLATION

8.1 If the Purchaser requests an alteration of the Contract, and Supplier accepts such alteration (which acceptance shall not be unreasonably withheld), the alteration will be deemed as a new Contract entitling Supplier to a restart of the Delivery time which will start to run on the date of the approval in writing by Supplier of the alteration.

8.2 All additional costs incurred as a result of the alteration will be charged to the Purchaser, in addition to the purchase price.

8.3 If the Purchaser cancels the Contract in whole or in part without cause, the Purchaser shall, unless otherwise agreed in writing, reimburse Supplier for (i) all costs and expenses incurred by Supplier under the Contract up until and including the date of cancellation, and (ii) any additional costs and expenses incurred as a result of the cancellation.

9. PRICES AND PAYMENT

9.1 The purchase price shall be the price for such Products set out in Supplier's price list as of the date for Delivery if not specifically set forth in the Contract. For domestic sales, payments shall be made within 30 days of the date of the invoice in the currency stipulated in the Contract, unless otherwise agreed in writing. For export sales, full payment in advance by telegraphic transfer is required in the currency stipulated in the Contract, unless otherwise agreed in writing.

9.2 Whatever the means of payment used, payment shall not be deemed to have been effected until Supplier's account has been fully and irrevocably credited.

9.3 If the Purchaser fails to pay by the stipulated date, Supplier shall be entitled to interest from the day on which payment was due. The statutory law interest rates shall apply.

9.4 In case of late payment, Supplier may suspend its performance of the Contract until payment is received.

9.5 Notwithstanding other rights to terminate the Contract under other clauses in these General Conditions, the Supplier shall, if the Purchaser has not paid the amount due within three (3) months, be entitled to terminate the Contract by notice in writing to the Purchaser and to claim compensation for the loss it has incurred.

9.6 Unless otherwise agreed to in writing, all prices are FCA Supplier's plant, and do not, even if Delivery is DAP in accordance with Clause 6.1 above, include transportation costs or charges relating to transportation. This means that in addition to the Product price, Purchaser shall compensate Supplier for all its transportation costs and charges, as set out in invoice from Supplier to Purchaser, despite that DAP delivery applies and such costs and charges shall thus be solely the responsibility of the Purchaser. Prices exclude special packing unless otherwise agreed to by Supplier in writing. All costs and taxes for packing shall be paid by the Purchaser as an additional charge. Such costs and charges are subject to change without notice.

9.7 The price for the Products does not include any applicable sales, use, excise, GST, VAT, or similar tax. The Purchaser shall have the responsibility for the payment of such taxes if applicable.

9.8 If, during the performance of the Contract, the financial condition of the Purchaser is such that Supplier in good faith and in application of usual banking standards deems a payment in time insecure, or if a material change in the ownership of the Purchaser occurs, or if the Purchaser fails to make any payments in accordance with the terms of its Contract with Supplier, then, in any such event, Supplier is not obligated to continue performance under the Contract and may stop goods in transit and defer or decline to make delivery of goods, except upon receipt of satisfactory security or cash payments in advance.

9.9 If the Purchaser fails to make payments or fails to furnish security satisfactory to Supplier, then Supplier shall have the right to enforce payment to the full Contract price of the work completed and in process.

9.10 Upon default by the Purchaser in payment when due, the Purchaser shall immediately pay to Supplier the entire unpaid amounts for any and all shipments made to the Purchaser irrespective of the terms of said shipment and whether said shipments are made pursuant to this Contract or any other contract of sale between Supplier or any of its affiliates and the Purchaser, and Supplier may withhold all subsequent shipments until the full amount is settled. Acceptance by Supplier of less than full payment shall not be a waiver of any of its rights hereunder.

10. WARRANTY, PURCHASER'S DUTIES IN WARRANTY CASES, REIMBURSEMENT OF EXPENSES, LIABILITY

10.1 Purchaser's warranty claims depend on his proper compliance with his statutory duties of examination and notification. Notifications have to include specific information on the alleged defect and shall be in writing. Notifications based on incomplete delivery or other obvious defects shall be notified to Supplier in writing without delay, but at the latest within 10 working days of the delivery arriving at its destination. Claims of Purchaser on account of a defectiveness or incompleteness are excluded if Purchaser fails to comply with this obligation.

10.2 In the case of product defects Supplier can elect to remove the defects or to provide a defect-free replacement. Only if this repeatedly fails or is unreasonable and the defect is not only insubstantial Purchaser is entitled to rescission or reduction of the purchase price in accordance with the statutory provisions. Sec. 445a BGB remains unaffected. Purchaser is entitled to claims for damages in accordance with Clause 10.5.

10.3 Concerning any replacement of products or removal of defects a warranty period of 3 months since delivery respectively the execution of service applies which runs, however, at least until the expiry of the warranty period of the original service (see Clause 10.7).

10.4 Purchaser has to inform Supplier immediately about each indication of product defects by his clients concerning Supplier's services. Should Purchaser not fulfil this obligation his claims for product defects against Supplier shall expire. Moreover, Purchaser has to safeguard proofs in adequate manner and to give Supplier the opportunity of examination at his request.

10.5 Supplier is liable without restriction under the Product Liability Act, in the event of an express assumption of a warranty or of a procurement risk or in the event of willful or grossly negligent violations of a duty. Supplier is also liable without restriction in the event of willful or negligent injury to life, physical well-being or health. In the event of Supplier's negligence (other than gross negligence) resulting in property or pecuniary damage, Supplier shall only be liable for a breach of essential contractual duties the fulfillment of which is inevitable for the proper performance of the contract and Purchaser can particularly rely on, however, limited to characteristic damages that were foreseeable at the time of signature.

10.6 No warranty is given for damages of all kind caused by improper treatment, change, installation and/or operation of the delivered product or by incorrect advice or instruction by Purchaser unless Supplier has caused those damages at least negligently.

10.7 Defect claims shall become time-barred after 12 months as of the statutory commencement of the limitation period. The same applies to legal defects. In the event of willful or grossly negligent breaches of a duty, claims arising from tortious acts, the absence of a warranted quality, the assumption of procurement risks or personal injury, the statutory time periods apply. Secs. 438 para. 3, 445b and 634a para. 3 BGB remain unaffected.

10.8 A further-reaching liability for damages than that provided in the paragraphs of this Clause 10. is excluded - without regard to the legal nature of the asserted claim.

10.9 The aforementioned restrictions of liability also apply, in terms of the reason and amount, in favour of Supplier's statutory representatives, employees and other vicarious agents.

11. ALLOCATION OF LIABILITY FOR DAMAGE CAUSED BY THE PRODUCT

11.1 Supplier shall not be liable for any damage to property or the environment caused by the Product after it has been delivered to the Purchaser. Nor shall Supplier be liable for any damage to products manufactured by the Purchaser, or to products of which the Purchaser's products form a part.

11.2 The Purchaser shall indemnify, defend and hold Supplier harmless to the extent that the Supplier incurs liability towards any third party in respect of loss or damage for which the Supplier is not liable according to the preceding paragraph.

11.3 If a claim for damages as described in this Clause 12 is lodged by a third party against one of the Parties, the latter party shall forthwith inform the other party thereof in writing.

11.4 Supplier and Purchaser shall be mutually obliged to let themselves be summoned to the court or arbitral tribunal examining claims for damages lodged against one of them on the basis of damage allegedly caused by the Product.

12. CONFIDENTIALITY

The Parties agree that any information received from the other party in connection with the Contract that evidently or by its nature should reasonably be understood to be confidential, shall not be disclosed by the recipient to any third party without the prior written approval of the disclosing party, except to the extent (i) this is necessary for the receiving party to exercise rights and perform duties pursuant to the Contract, (ii) the information is available to the general public or later becomes publicly available other than through a breach of the Contract, (iii) the information is actually known to the receiving party on the date that such information is disclosed as evidenced

by written records in existence prior to the date of the receipt, (iv) the information is subsequently lawfully obtained by the receiving party from a third party or third parties, or (v) the information is independently developed by the receiving party prior to the disclosure.

13. FORCE MAJEURE

13.1 Either party shall be entitled to suspend performance of its obligations under the Contract to the extent that such performance is impeded or made unreasonably onerous by any of the following circumstances: industrial disputes and any other circumstance beyond the control of the parties such as pandemic, fire, earthquake, natural disaster, acts of God, war, extensive military mobilization, insurrection, requisition, seizure, embargo, acts of governments, strikes, lockouts, restrictions in the use of power and defects or delays in deliveries by sub-contractors ("Force Majeure").

13.2 The party claiming to be affected by Force Majeure shall notify the other party in writing without delay on the intervention and on the cessation of such circumstance.

13.3 If Force Majeure prevents the Purchaser from fulfilling its obligations, it shall compensate Supplier for expenses incurred in securing and protecting the Product.

13.4 Regardless of what might otherwise follow from these General Conditions, either party shall be entitled to terminate the Contract by notice in writing to the other party if performance of the Contract is suspended under this Clause 14 for more than six (6) months.

13.5 If the Purchaser terminates the Contract due to Force Majeure, the Purchaser shall, unless otherwise agreed in writing, reimburse Supplier for (i) all costs and expenses incurred by Supplier under the Contract up until and including the date of the termination and (ii) any additional costs and expenses incurred as a result of the termination.

14. ASSIGNMENT

The Purchaser shall not assign or transfer this Contract or any interest in it, or monies payable under it, without the prior written consent of Supplier and any assignment made without such consent shall be null and void. Supplier may assign its rights and/or delegate its duties in whole or in part to any affiliated company. Supplier shall notify Purchaser of any such assignment or delegation.

15. INVALIDITY

If any provision of this Contract is held to be illegal, invalid, or unenforceable by any court of competent jurisdiction, such provision will be of no force and effect, but the illegality, invalidity, or unenforceability will have no effect upon and will not impair the enforceability of any other provision of this Contract. The illegal, invalid or unenforceable provision shall be deemed to be substituted by a suitable provision which, to the extent legally permissible, comes as close as possible to the intent and purpose of the illegal, invalid or unenforceable provision. The same shall apply if the parties have unintentionally failed to address a certain matter in this Contract.

16. EXPORT REGULATIONS

The Purchaser has to comply with all legal provisions and administrative requirements as well as all other applicable laws, and in particular export regulations and the laws of the country in which the Purchaser operates. The Purchaser has to obtain all necessary approvals and licenses as well as all necessary permissions in good time, which are, according to all these applicable laws, required for the use or the export of the delivery item.

The Supplier is entitled to withhold his goods and services vis-à-vis the Purchaser if the Purchaser would violate those applicable laws or if not all necessary permissions are available and if this is not based on the Supplier's fault or responsibility.

The performance of the contract on the part of the Supplier is on condition that there are no opposing impediments due to national or international foreign trade legislation as well as embargos (and/or other sanctions).

The US Export Administration Regulations (EAR) are equally to be respected. Rights and duties of the Purchaser according to this clause endure after the expiration and premature termination of this Contract.

17. PLACE OF PERFORMANCE

Place of performance shall be the Supplier's place of business.

18. DISPUTES AND APPLICABLE LAW

18.1 All disputes arising out of or in connection with the Contract shall be finally settled by the competent courts of Weilheim, Germany, yet it is in the discretion of the Supplier to initiate court proceedings also at the Purchaser's place of business or, in disputes regarding bills of exchange, at the place of payment of the bills of exchange.

18.2 The Contract shall be governed by the substantive law of Germany, excluding the application of the Convention on International Sales of Goods (CISG).



www.ebro.com

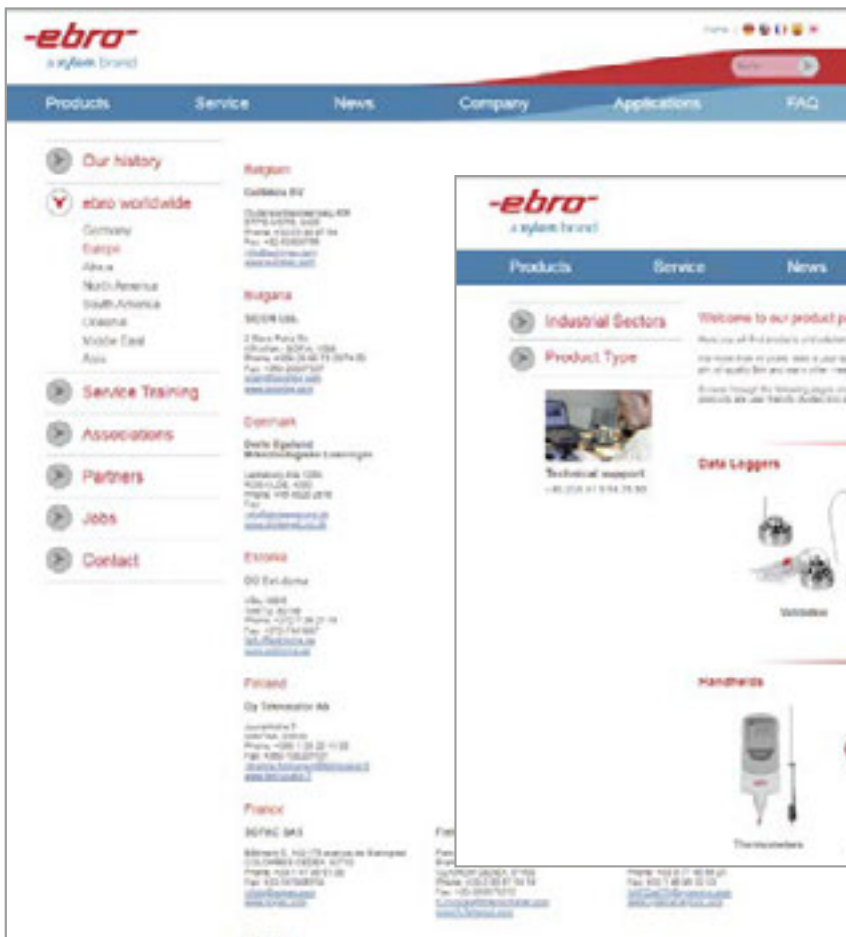



Endoscope-Dummy for operation and process qualification

With the patented endoscope dummy developed by spypach® and the ebro® data loggers, the cleaning and disinfection performance of the washer-disinfector is tested independently of the WD manufacturer.

The endoscope dummy is simply inserted into the WD-E instead of an endoscope with the associated data logger. The innovative solution enables simple and fast routine checks, simplifies validation and thus ensures maximum patient safety and a minimum of testing costs.

Independent test system for endoscope, cleaning and disinfection devices

- Reproducible performance check of washer-disinfectors for flexible endoscopes
- Excellent validation support
- tested according to standard EN ISO15883
- easy routine checks



The thermal test of the endoscope reprocessing is possible with the independent spypach® test system and the EBI 11 data loggers.

The suitable data loggers from the EBI 11 series can be found from page 33.



Type	Description	Part No.
spypach® Dummy Basic	Endoscope dummy „spo-pro“ BASIC for routine control, without data logger	1340-6086
spypach® Dummy Classic	Endoscope dummy „spo-pro“ CLASSIC for routine control and validation, without data logger	1340-6087
spypach® Dummy Professional	Endoscope dummy „spo-pro“ PROFESSIONAL for routine control and validation with extensive accessories for single channel control, without data logger, with carrying case.	1340-6088
AL 133	Adapter for temperature logger, 1/8" to M5 thread	1248-0133
AL 134	Adapter for pressure logger, 1/8" to Luerlock	1248-0134
AL 135	Adapter for pressure logger, M12 to Luerlock	1248-0135

Index by Type

AG 152	69
AH 100	67
AH 100	75
AH 300	67
AH 300	75
AL 101	32
AL 102	32
AL 104	32
AL 106	32
AL 107	32
AL 111	32
AL 112	32
AL 113	40
AL 113L	40
AL 114	40
AL 115	40
AL 116	69
AL 120	32
AL 120 PS	69
AL 121	32
AL 122	32
AL 126	55
AL 127	56
AL 128	56
AL 132	32
AL 175 TH probe	26
AL 190	32
AL 250	69
AL 251	69
AL 252	69
AL 285	32
AL 1100	56
AL 1101	56
AL 1102	56
AL 1103	56
AL 1105	56
AL 1106	56
AL 1107	56
AL 1108	56
AL 3304	54
AL 3305	52
AL 3306	54
AL 3307	54
AL 3308	54
AL 3309	54
AL 3310	54
AL 3311	54
AN 142	63
AN 144	63
AT 830 C Binder	58
AT 830 pH E Binder	58
AT 830 pH G Binder	58
AT 830 pH K Binder	58
Battery	69
CT830 SET	57
Dummy 0,5L	32
Dummy 0,7L	32
Dummy 1L	32
Dummy C	32
Dummy E	32
EBI 2 AB-2	69
EBI 11-P100	37
EBI 11-P111	37
EBI 11-T210	34
EBI 11-T230	34
EBI 11-T231	34
EBI 11-T233	34
EBI 11-T235	35
EBI 11-T236	35
EBI 11-T237	35
EBI 11-T237	53
EBI 11-T240	35
EBI 11-TP110	38
EBI 11-TP210	38
EBI 12-T100	11
EBI 12-T100-EX	11
EBI 12-T100-EYELET	11
EBI 12-T101	11
EBI 12-T101-EYELET	11
EBI 12-T102	11
EBI 12-T210	12
EBI 12-T211	12
EBI 12-T220	15
EBI 12-T220-EX	15
EBI 12-T221	15
EBI 12-T222	15
EBI 12-T230	12
EBI 12-T231	12
EBI 12-T232	12
EBI 12-T233	12
EBI 12-T237	12
EBI 12-T240	15
EBI 12-T241	15
EBI 12-T261	14
EBI 12-T262	14
EBI 12-T263	14
EBI 12-T264	14
EBI 12-T265	14
EBI 12-T285	13
EBI 12-T421	16
EBI 12-T430	13
EBI 12-T431	13
EBI 12-T432	13
EBI 12-T433	13
EBI 12-T441	16
EBI 12-T441-EX	16
EBI 12-T461	14
EBI 12-T462	14
EBI 12-T463	14
EBI 12-T464	14
EBI 12-T465	14
EBI 12-T470	18
EBI 12-T471	18
EBI 12-T480	25
EBI 12-T490	17
EBI 12-T671	18
EBI 12-T690	17
EBI 12-TP230	25
EBI 12-TP100-EX	26
EBI 12-TP190	24
EBI 12-TP222	20
EBI 12-TP226	20
EBI 12-TP231	21
EBI 12-TP231-EX	21
EBI 12-TP234	22
EBI 12-TP237	22
EBI 12-TP290	24
EBI 12-TP322	22
EBI 12-TP422	23
EBI 12-TP451	23
EBI 12-TP453	23
EBI 12-TP460	24
EBI 16	27
EBI 25-T	66
EBI 25-TE	66
EBI 25-TH	67
EBI 25-TX	67
EBI 25-TX	67
EBI 40-TC-01	63
EBI 40-TC-02	63
EBI 40-WH	63
EBI 300 WM3	73
EBI 310	73
EBI 310 TE	74
EBI 310 TH	75
EBI 310 TX	75
EBI DA	32
EBI DA-Set	32
EBI FLS	32
EBI IF 400	69
EBI IF 830	59
EBI KV-3	32
EBI NI-140	32
EBI TIB2	32
EBI TIB 400-01	63
E-Set Trace	58
IQ/OQ Winlog.pro	83
IQ/OQ Winlog.web	85
KCI-250	58
PHT 830 SET1	57
PHX 800	59
PL 4	58
PL 7	58
PL 9	58
PT 1000 Probe	25
SI 1100	32
SI 1100	40
SI 1200	32
SI 1300	40
SI 2100	32
SI 2100	40
SI 2110	32
SI 2150	32
SI 3200	32
SI 3300	40
SL 1011	44
SL 1111	45
SL 1521	46
SL 1621	46
SL 2002	50
SL 3001	51
SL 3101	51
SL 3111	52
SL 3302	53
SL 4002	47
SL 4003	47
SL 4004	47
SL 4021	48
SL 4022	48
SL 4023	48
SL 4024	48
SL 4102	48
SL 4121	49
SL 4122	49
SL 4123	49
SL 4124	49
SL 4125	49
SL 4211	49
TDS 3	59
TPH 500	75
TPN 611-3	63
TPX 25-3	67
TPX 25-5	67
TPX 25-7,5	67
TPX 25-10	67
TPX 220	74
TPX 220-3	74
TPX 310	75
TPX 310-P1	76
TPX 310-P2	76
TPX 310-P3	76
TPX 310-P4	76
TPX 310-P5	76
TPX 310-P6	76
TPX 310-P7	76
Winlog.med	87
Winlog.pro	83
Winlog.validation	87
Winlog.web	69
Winlog.web	85

Index by Part No.

1030-2203	89	1340-2390	69	1340-6697	27
1030-2204	89	1340-2390	85	1341-0025	67
1030-2205	89	1340-2394	87	1341-0026	67
1030-2223	89	1340-5625	67	1341-0027	67
1030-2224	89	1340-5625	75	1341-0028	67
1030-2225	89	1340-5627	67	1341-6332-0100A	74
1030-2302	89	1340-5627	75	1341-6332A	74
1030-2303	89	1340-5800	59	1341-6335A	75
1030-2304	89	1340-5812	57	1341-6337A	75
1030-2322	89	1340-5831	59	1341-6338	76
1030-2323	89	1340-5835	57	1341-6339	76
1030-2324	89	1340-6006	32	1341-6340	76
1030-2403	89	1340-6007	32	1341-6341	76
1030-2404	89	1340-6011	59	1341-6342	76
1030-2405	89	1340-6021	32	1341-6343	76
1030-3203	90	1340-6022	32	1341-6344	76
1030-3204	90	1340-6023	32	1343-0800-0100	63
1030-3205	90	1340-6024	32	1343-2626	63
1030-3223	90	1340-6061	32	1343-2627	63
1030-3224	90	1340-6061	40	1613-1301	69
1030-3225	90	1340-6062	32	109110	58
1030-3302	90	1340-6063	40	109120	58
1030-3303	90	1340-6064	32	109130	58
1030-3304	90	1340-6064	40	109705	58
1030-3322	90	1340-6068	32	300572	58
1030-3323	90	1340-6069	40		
1030-3324	90	1340-6095	32		
1030-3403	90	1340-6096-0001	56		
1030-3404	90	1340-6096-0003	56		
1030-3405	90	1340-6096-0009	56		
1100-0118	32	1340-6096-0010	56		
1100-0120	40	1340-6193	32		
1100-0121	69	1340-6200A	66		
1100-0125	40	1340-6201A	66		
1100-0130	32	1340-6202A	67		
1100-0131	32	1340-6204A	67		
1220-0350	69	1340-6210	69		
1220-0355	69	1340-6211	69		
1248-0122	32	1340-6215	69		
1248-0126	55	1340-6233	69		
1248-0127	56	1340-6270	35		
1248-0128	56	1340-6271	35		
1248-0132	32	1340-6272	35		
1248-0190	32	1340-6272	53		
1248-0250	69	1340-6291	35		
1248-0285	32	1340-6295	37		
1248-1100	56	1340-6296	37		
1248-1101	56	1340-6297	38		
1248-1102	56	1340-6298	40		
1248-1103	56	1340-6299	40		
1248-3304	54	1340-6331A	73		
1248-3305	52	1340-6336A	75		
1248-3306	54	1340-6337A	74		
1248-3307	54	1340-6339A	75		
1248-3308	54	1340-6341	73		
1248-3309	54	1340-6344	73		
1248-3310	54	1340-6400	63		
1248-3311	54	1340-6401	63		
1250-1011	44	1340-6430	63		
1250-1111	45	1340-6431	63		
1250-1521	46	1340-6600	11		
1250-1621	46	1340-6600-0100	11		
1250-2002	50	1340-6600-EX	11		
1250-3001	51	1340-6601	11		
1250-3101	51	1340-6601-0100	11		
1250-3111	52	1340-6602	12		
1250-3302	53	1340-6603	12		
1250-4002	47	1340-6604	15		
1250-4003	47	1340-6604-EX	15		
1250-4004	47	1340-6605	15		
1250-4021	48	1340-6606	12		
1250-4022	48	1340-6607	12		
1250-4023	48	1340-6608	12		
1250-4024	48	1340-6609	12		
1250-4102	48	1340-6610	15		
1250-4121	49	1340-6614	13		
1250-4122	49	1340-6615	13		
1250-4123	49	1340-6616	13		
1250-4124	49	1340-6617	13		
1250-4125	49	1340-6618	14		
1250-4211	49	1340-6619	14		
1339-0660	58	1340-6620	14		
1339-0661	58	1340-6621	14		
1339-0662	58	1340-6622	14		
1339-0663	58	1340-6623	14		
1340-0025	67	1340-6624	14		
1340-1892	32	1340-6625	14		
1340-1961	32	1340-6626	14		
1340-1963	32	1340-6627	14		
1340-1984	32	1340-6629-EX	16		
1340-1988	32	1340-6635	17		
1340-2005	32	1340-6636	11		
1340-2255	32	1340-6637	12		
1340-2256	32	1340-6648	24		
1340-2257	32	1340-6652	22		
1340-2258	32	1340-6653	20		
1340-2259	32	1340-6655	21		
1340-2286	83	1340-6657	20		
1340-2290	85	1340-6658	22		
1340-2355	83	1340-6662	23		
1340-2363	87	1340-6685	13		

Our Services for You

At ebro® service is more than just a word – ebro® offers solutions according to customer wishes.

For us, Service means more than the usual software hotline, calibration service, repairs, etc. We are dedicated to understanding the needs of our customers and offering them the best possible solutions.

It makes no difference if you need to have a handheld instrument repaired or a thermometer calibrated - we are glad to be of service. Just call!

Repairs & Calibration

Tel.: +49 841 95478-55

Fax: + 49 841 95478-80

E-Mail: ebro@xyleminc.com



Service and Calibrations

We are happy to perform your calibration for temperature, pressure and relative humidity in our accredited DAkkS laboratory for you. Please just contact us.



IQ / OQ Documentation

Of course, you will receive an IQ / OQ documentation of the system according to the GAMP guidelines.

Maintenance, Fieldservice & Calibration at customers location

Willi Harrer

Tel.: +49 841 95478-57

Mobil: +49 173 9580664

Fax: +49 841 95478-80

Willi.Harrer@xyleminc.com

Marcus Scheller

Tel.: +49 841 95478-51

Mobil: +49 173-9580674

Fax: +49 841 95478-80

Marcus.Scheller@xyleminc.com



Xylem | 'zīləm|

- 1) The tissue in plants that brings water upward from the roots;
- 2) a leading global water technology company.

We're a global team unified in a common purpose: creating advanced technology solutions to the world's water challenges. Developing new technologies that will improve the way water is used, conserved, and re-used in the future is central to our work. Our products and services move, treat, analyze, monitor and return water to the environment, in public utility, industrial, residential and commercial building services settings. Xylem also provides a leading portfolio of smart metering, network technologies and advanced analytics solutions for water, electric and gas utilities. In more than 150 countries, we have strong, long-standing relationships with customers who know us for our powerful combination of leading product brands and applications expertise with a strong focus on developing comprehensive, sustainable solutions.

For more information on how Xylem can help you, go to www.xylem.com

-ebro-[®]



/ebrogmbh



/ebro.ingolstadt

xylem
Let's Solve Water

Xylem Analytics Germany Sales GmbH & Co. KG, ebro
Peringerstr. 10
85055 Ingolstadt, Germany
Tel +49 841 95478-0
Fax +49 841 95478-80
ebro@xylem.com
www.xylemanalytics.com